



D2SV IP Phone User Manual

Version: 1.0

2022-08-03

Content

| | |
|------------------------------------------------------------------------------------|------------|
| Contact ATCOM | 5 |
| 1. Overview of D2SV | 6 |
| 1.1. Interface | 7 |
| 1.2. Hardware | 7 |
| 1.3. LTE data parameters | 7 |
| 1.4. Software | 8 |
| 1.5. Network | 9 |
| 1.6. Management and Maintenance | 9 |
| 1.7. Protocol | 9 |
| 1.8. Compliant and Certified Standard | 10 |
| 1.9. Packing list | 10 |
| 1.10. Connection | 11 |
| 1.10.1. LTE network | 11 |
| 1.10.2. Wi-Fi Network (the phone must support Wi-Fi mode) | 11 |
| 1.10.3. LAN port instructions (the phone need to support the LAN port model) | 12 |
| 1.11. Installation | 12 |
| 1.11.1. Connecting port introduction | 12 |
| 1.11.2. Installation instruction | 13 |
| 1.11.3. Connection instruction | 错误! 未定义书签。 |
| 2. Call Function | 15 |
| 2.1. Answer the calls | 15 |
| 2.2. Make Calls | 16 |
| 2.3. Pre-dial | 18 |

| | | |
|--------|------------------------------------------|----|
| 2.4. | Multiple line dial-up | 18 |
| 2.5. | Call Hold | 18 |
| 2.6. | Call Transfer | 19 |
| 2.7. | Mute calls | 19 |
| 2.8. | 5-Way Conference | 19 |
| 2.9. | Hang up the phone | 21 |
| 2.10. | Voicemail | 21 |
| 3. | Keypad and GUI | 22 |
| 3.1. | Keypad | 22 |
| 3.2. | Starting | 24 |
| 3.3. | Standby | 25 |
| 3.4. | Configuration | 27 |
| 3.4.1. | Status info | 27 |
| 3.4.2. | Call Features | 29 |
| 3.4.3. | Contacts | 42 |
| 3.4.4. | History | 49 |
| 3.4.5. | Message | 52 |
| 3.4.6. | Settings | 53 |
| 3.4.7. | Display | 71 |
| 4. | Advanced Feature | 73 |
| 4.1. | Codecs | 73 |
| 4.2. | Capture and Upgrading | 74 |
| 4.3. | Auto Provision | 75 |
| 4.4. | Export & Import configuration file | 77 |
| 4.4.1. | Export configuration file | 77 |

| | | |
|--------|-------------------------------------------------------|----|
| 4.4.2. | Import configuration file..... | 78 |
| 4.5. | Export System log | 78 |
| 4.6. | Dial plan | 79 |
| 4.6.1. | Replace Rule | 80 |
| 4.6.2. | Dial-now | 81 |
| 4.6.3. | Area Code..... | 82 |
| 4.6.4. | Block Out..... | 83 |
| 5. | WI-FI..... | 84 |
| 5.1. | Configure the WIFI on the phone | 84 |
| 5.2. | Configure the WIFI on the WEB | 84 |
| 5.3. | Enterprise WiFi | 85 |
| 6. | LTE Network..... | 86 |
| 6.1. | Configure the LTE on the phone | 86 |
| 6.2. | Configure the account on the LTE network | 86 |
| 7. | FAQ..... | 87 |
| 7.1. | How to reset to factory | 87 |
| 7.2. | Upgrade the firmware on safe mode | 88 |
| 7.3. | How to make IP Peer to Peer call | 88 |
| 8. | Troubleshooting..... | 90 |
| 8.1. | The phone is failed to register to SIP server | 90 |
| 8.2. | The phone is failed to gain IP address | 90 |
| 8.3. | Only one party can hear from another on calling | 90 |
| 9. | Abbreviation..... | 91 |
| 10. | FCC Caution..... | 92 |

Contact ATCOM

Overview of ATCOM

ATCOM is the leading VoIP hardware manufacturer in global market. We have been keeping innovating with customer's needs oriented , working with partners to establish a total solution for SMB VoIP with IP phone , IP PBX and Asterisk cards.

With over 10 years' experience of R&D , manufacturing and service in network and VoIP filed;mission of creating the biggest value for IP terminals , we commit ourselves in supplying the competitive IP phone and other terminals for IP PBX , softswitch , IMS , NGN providers and carriers; supplying the competitive total VoIP solution for SMB market. We keep improving the customer's experience and creating the bigger value with our reliable products. Until now, our VoIP products have been available in 100+ countries and used by millions of end users.

Contact Sales

| | |
|---------|----------------------------------------------------------------------------------------------------------------------|
| Address | Area C, A2F , Block 3 ,Huangguan Technology Park , #21 Tairan 9th Rd, Chegongmiao , Futian District , Shenzhen China |
| Tel | + (86) 755-83018618 |
| Fax | + (86) 755-83018319 |
| E-mail | sales@atcom.com.cn |

Contact Technical Support

| | |
|--------|----------------------------------------------------------------|
| Tel | + (86) 755-83018618 |
| E-mail | Support@atcom.com.cn |

Website Address: <http://www.atcom.cn/>

1. Overview of D2SV

D2SV-PW is an innovative 4G dual-mode IP phone, which is applied to 4G environment and supports both standard SIP protocol and carrier VoLTE. It can not only use SIP protocol to deploy enterprise intranet number and PSTN fixed number, but also deploy carrier VoLTE mobile number. For D2SV-PW, the routing function of built-in 4G ethernet port and 4G Wi-Fi hotspots allow users to access 3G/4G data networks while using voice. D2SV-PW is suitable for operators to support their ending customers who need both voice and network, and also suitable for enterprises to apply in internal voice system data network construction, especially for enterprises that need internal voice system and mobile phone number and to use at the same time. D2SV-PW VoLTE mode is not only compatible with most 4G operators' VoLTE systems, but also allows users to experience excellent voice quality. Its SIP mode is not only compatible with common brands of enterprise IP PBX and cloud IP PBX, but also support applications in enterprise voice system.



D2SV

| | D2SV-PW | D2SV-P | D2SV-W | D2SV | D2SV-LW | Notes: If the suffix -S is added to each model in the form, example D2SV-S; If the suffix -V is added it means that only it means that only SIP is supported and VoLTE is not supported, and SIP is not supported; example: D2SV-V |
|----------------|---------|--------|--------|------|---------|------------------------------------------------------------------------------------------------------------------------------------------------------------------------------------------------------------------------------------|
| Network | 2Pcs | 2Pcs | 1Pcs | 1Pcs | No | |
| Wi-Fi | Yes | No | Yes | No | Yes | |
| SIP | Yes | Yes | Yes | Yes | Yes | |
| VoLTE | Yes | Yes | Yes | Yes | Yes | |

1.1. Interface

| | |
|---------------------------|-----------------------------------------------|
| Power Input | Note: D2SV uses 5V/1A, other models use 5V/2A |
| LAN Port | RJ45 |
| PC Port | RJ45 |
| Headset Jack | RJ9 |
| Handset Jack | RJ9 |
| LTE Nano card Port | Nano-SIM card port |

1.2. Hardware

| | |
|----------------------|------------------------------------|
| LCD | 132*52 |
| CPU | 400MHz Dual-Core |
| LED Indicator | 1 Status Light , 2 line indicators |

1.3. LTE data parameters

| | | |
|---------------------------|-----------------|-----------------------------------------------------------------------------------------|
| LTE Frequency band | | LTE FDD: B1/ B3/ B8 |
| | | LTE TDD: B38/ B39/ B40/ B41 |
| | | TDSCDMA: B34/ B39 |
| | | WCDMA :B1/ B8 |
| LTE Version | | 3GPP E-UTRA Release 11 |
| Bandwidth | | 1.4 /3 /5 /10/20MHz |
| Antenna | | DL MIMO, Support receive diversity |
| Data | LTE | LTE FDD: Max 1500Mbps (DL) Max 50Mbps (UL) LTE TDD: Max 130Mbps (DL) Max 35Mbps (UL) |
| | DC-HSPA+ | Max 42Mbps (DL) Max 5.76Mbps (UL) |
| | UMTS | Max 384Mbps (DL) Max 384Mbps (UL) |
| | TD-SCDMA | Max 4.2Mbps (DL) Max 2.2Mbps (UL) |
| | CDMA | Max 3.1Mbps (DL) Max 1.8Mbps (UL) |
| | EDGE | Max 236.8Kbps (DL) Max 236.8Kbps (UL) |
| | GPRS | Max 85.6Kbps (DL) Max 85.6Kbps (UL) |

Note: Different modules of D2SV support different LTE bands, please connect ATCOM technical support for details.

1.4. Software

- Support VoLTE voice and data (Note: VoLTE voice cannot support all the D2SV modules)
- Support Wi-Fi
- Sip 2.0 (RFC3261) and other related SIP RFCs
- 6 SIP accounts registration
- Jitter Buffer, VAD, CNG
- Supported codec: G711A, G711U, G722, L16, iLBC_13_3, iLBC_15_2, OPUS, G729
- Echo Cancellation
- SIP Domain name, Authentication and Backup SIP Server
- DTMF (RFC2833, Inband, SIP INFO)
- Call transfer, Call forward, 3-way conference, Call hold, Call back
- DND(Do Not Disturb), Auto answer, Blacklists, Block Call-ID, Block Anonymous call, Dial plan, IP call
- Phone book with 1000 contacts and 50 blacklists

- Call History with 400 records include answered calls, missed calls, dialed calls and forward calls
- Auto update via HTTP, HTTPS, FTP, TFTP, DHCP, RPS and PNP
- Syslog
- SNTP, NTP
- Customized Ringtone
- Daylight Saving time
- VLAN, OpenVPN, Span to PC port, QoS
- Enterprise WIFI
- WEB access with different login level
- Soft button: soft button *3
- Redundancy SIP server
- Multi-language: English, French, Hebrew, Russian, Spanish, Simplified or Traditional Chinese, Persian, Polish, Portuguese, Turkish, German, Italian
- Support 2.4GHz WiFi
- Support 4G(LTE) & 3G

1.5. Network

- LAN port: support router mode
- Support Open VPN
- Primary/SecondaryDNS Server
- Support QoS
- Support Enterprise WIFI
- Web access via HTTP&HTTPS
- Support 2.4GHz WiFi with 802.11n protocol
- Support 4G(LTE) and 3G access
- Support TR069

1.6. Management and Maintenance

- Support firmware updating under safe mode
- Support different level user management
- Configuration via web , keyboard
- Support multi-language
- Firmware and configuration file auto provision
- Support system log

1.7. Protocol

- IEEE 802.3 /802.3 u 10 Base T / 100Base TX

- DHCP: Dynamic Host Configuration Protocol
- SIP RFC3261, RFC3262, RFC3263, RFC3264, RFC3265, RFC2543, RFC3489, RFC3842, RFC3515, RFC2976, RFC3428, RFC2327, RFC2782, RFC1889
- TCP/IP: Transfer Control Protocol/Internet Protocol
- RTP: Real-time Transport Protocol
- RTCP:RTP Control Protocol
- DNS: Domain Name Server
- TFTP: Trivial File Transfer Protocol
- HTTP:Hypertext Transfer Protocol
- FTP:File Transfer Protocol

1.8. Compliant and Certified Standard

- EC: EN 55032:2015/A11:2020 EN IEC 61000-3-2:2019 EN 61000-3-3:2013/A1:2019 EN 55035:2017/A11:2020
- Comply with ROHS in EU
- Comply with ROHS in China



-
- Operating temperature: -10 ~ 50°C
- Storage temperature: -10 ~ 50°C
- Operating humidity: 10 ~ 90%

1.9. Packing list

| Model | D2SV |
|------------------|--------------------|
| Telephone | 1 Unit |
| Handset | 1 Unit |
| Handset cable | 1 Unit |
| Stand bracket | 1 Unit |
| Wall bracket | 1 Unit |
| Power adapter | Optional |
| Network Cable | 1 Unit, 1.5 meters |
| Quickstart Guide | 1 Unit |

| | |
|----------------|----------|
| Headset | Optional |
|----------------|----------|

1.10. Connection

1.10.1. LTE network

The phone insert the SIM card, and get the LTE or 3G network after the phone power on.

When the phone is successfully connected to the network, the LCD would appear the icon .

The topology is as follows:

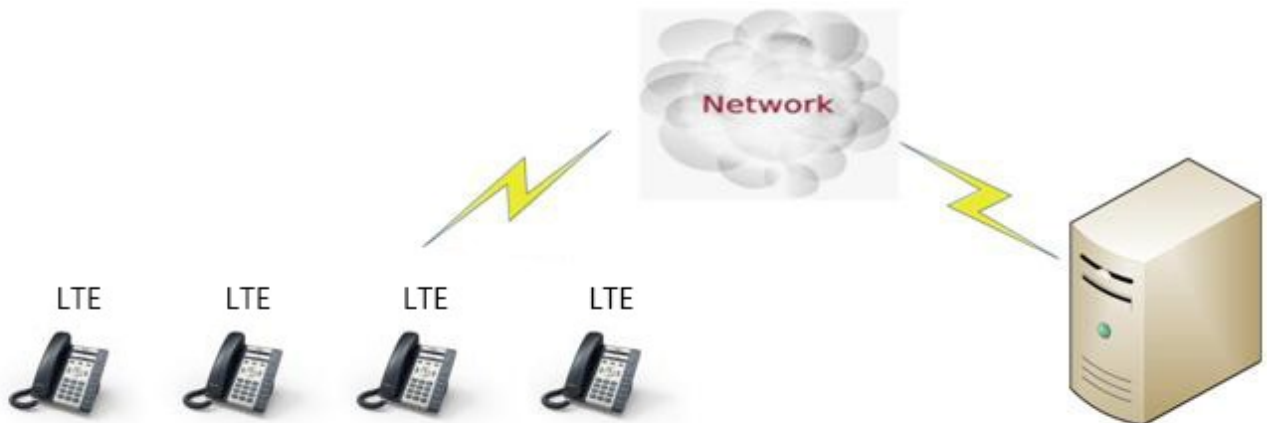

Note: LTE network support LAN port routing feature, and the default DHCP network segment is 192.168.225.X. and connect the port to the PC, the phone default IP address is 192.168.225.1.

1.10.2. Wi-Fi Network (the phone must support Wi-Fi mode)

1.10.2.1 Wi-Fi hotspot (Wi-Fi AP) mode

The phone turns on the Wi-Fi hotspot (Wi-Fi AP) function by default, the LCD would appear the icon .

The **initial SSID** and **password** of the hotspot can be viewed on the sticker on the phone back cover.

Please press **Menu→Wi-Fi Settings→ Hotspot**, you can choose to turn on or off the hotspot, and press the down navigation key to view or modify the initial name and password.

1.10.2.2 Wi-Fi network card mode

Please press **Menu→Wi-Fi Settings→WLAN**, select the Wi-Fi SSID and input the password, then press the Connect button, the phone would connect the Wi-Fi and the LCD would show the icon 

(Note: Hotspot and Wi-Fi function cannot be used at the same time)

1.10.3. LAN port instructions (the phone need to support the LAN port model)

When the phone is on an LTE network or connecting the Wi-Fi WLAN, the LAN port supports the routing feature, and other devices can get the network by connecting to the phone LAN port.

1.11. Installation

1.11.1. Connecting port introduction

The **D2SV** connecting port introduction,

From as below picture show the connecting port and insert the standard Nano-SIM card into the back cover way:

(Note: please don't plug in and off Nano card when the phone connected power)

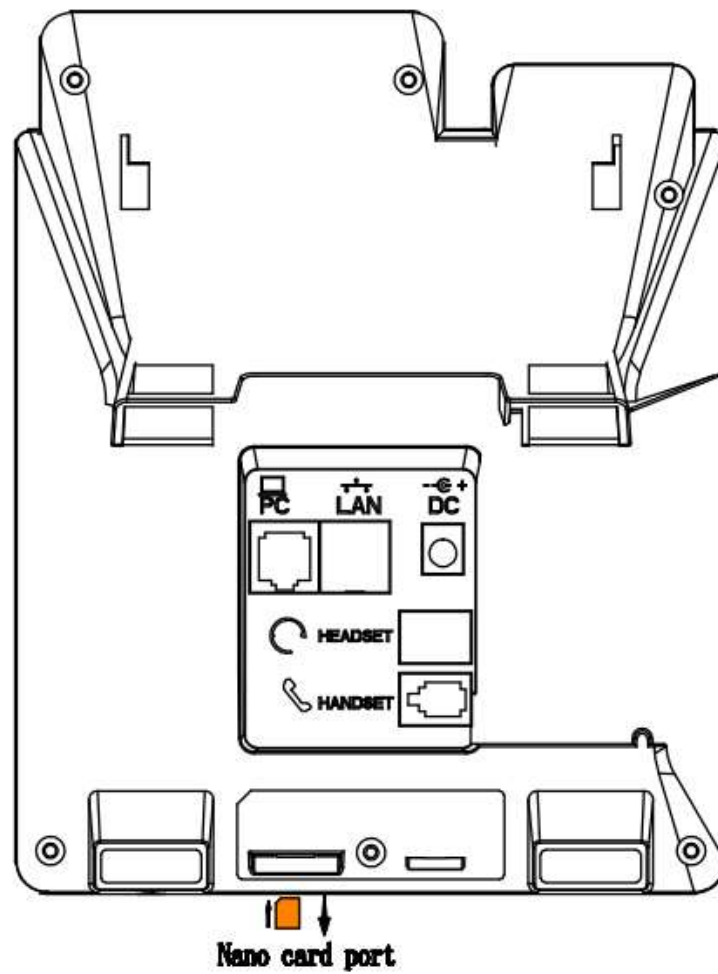

1.11.2. Installation instruction

- A. Bottom up the IP phone, press the joints of stand bracket into the slots and push it to the right to fasten:

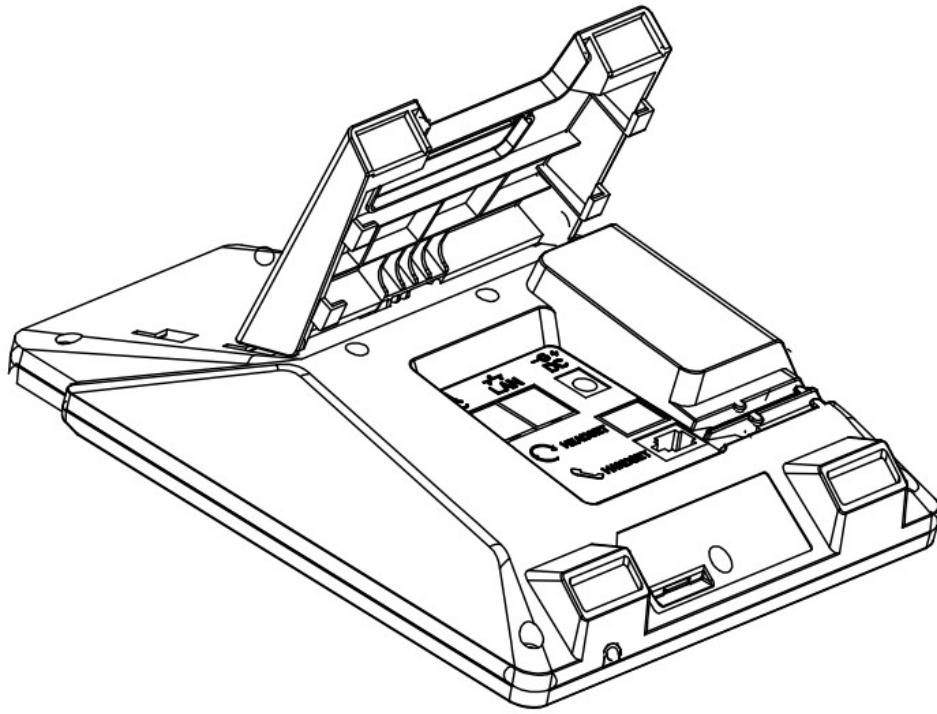

B. After installation, the picture is as below:

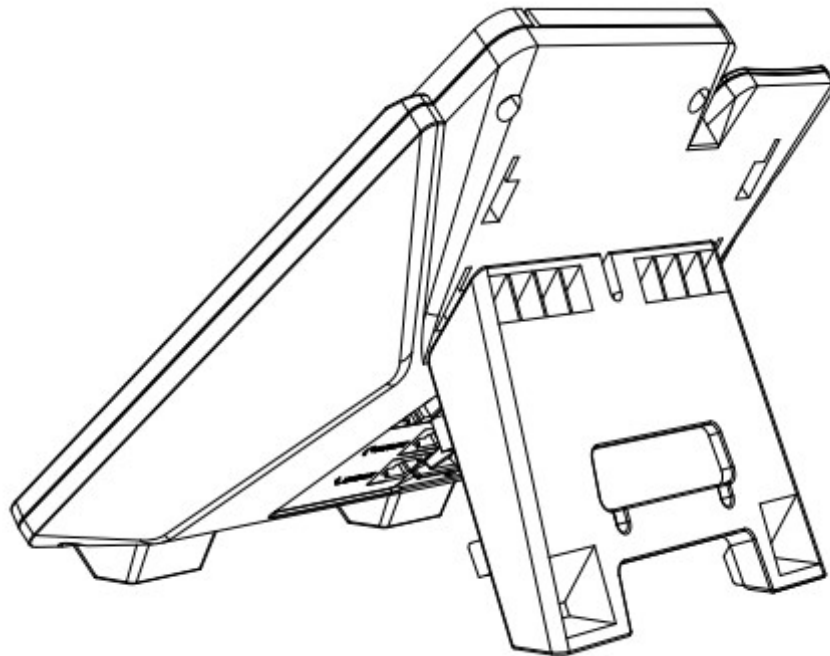

C. Remove the stand bracket:

Push the joint of stand to left and pull the stand according to the direction of the arrow. When the joints are pulled out of the slot, you can take off the stand bracket

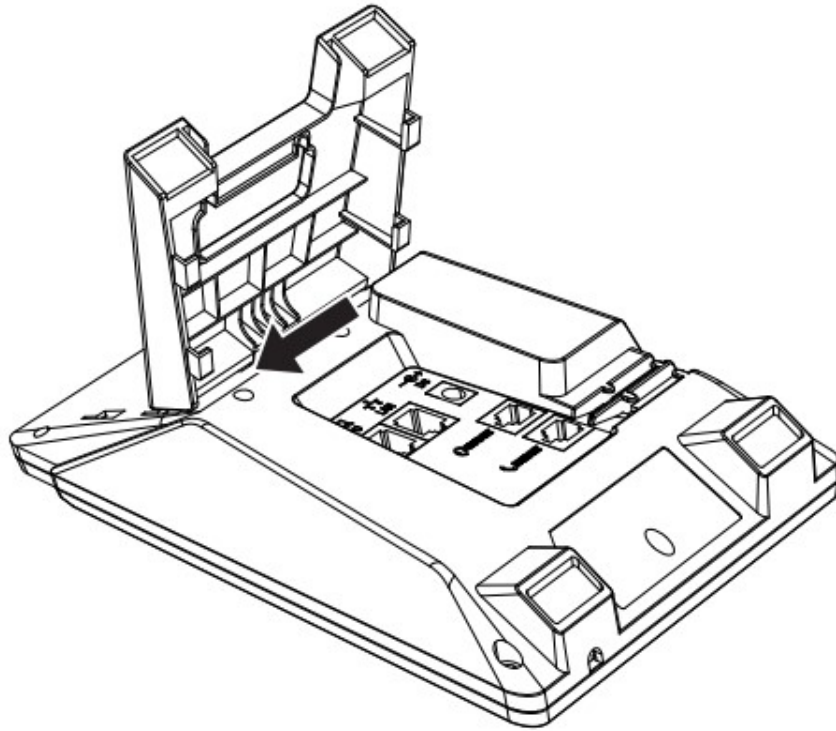



2. Call Function



2.1. Answer the calls

When there is an incoming call, phone will remind user with ringing. There are 3 ways to answer the call:



A. Answer by handset

Pick up the handset and talk with the caller. If you want to hang up, just put back the handset. When you are talking with the handset and want to switch to speaker or headset mode, please press  key or  key, and then put down the handset.

B. Answer by speaker

Press  key and talk with callers by built-in Micro-phone and Speaker. If you want to hang up, please press  key again. Switch calling or talking into handset mode by lifting the handset under speaker mode. Press  key will switch calling or talking into headset mode.

C. Answer by headset

Keep your microphone connected with the RJ9 headset jack, when there is an incoming call, press  and talk with the caller. If you want to hang up, please press  again. Pressing  can change calling or talking into speaker mode, and lifting the handset switches to handset mode.

2.2. Make Calls

A. Use the handset

Pickup the handset, the LCD will show the current lines (user is able to switch from line1 to line6 by pressing the line key beside the LCD). Press soft key "**Send**" to dial the number. When you hear the tones of "du~~du~~" and the phone number your dialed is being displayed on the LCD, the phone at the side of being called should be ringing. If the called party answers this calling, the call is established and the calling timer is started immediately.

B. Use the speaker



Press  key, the LCD will show the current lines (user is able to switch from line1 to line6 by pressing the line key beside the LCD). Input the phone number and press soft key "**Send**" to dial the number. When caller hear the tones of "du~~du~~" and the phone number your dialed is being displayed on the LCD, the phone at the side of being called should be ringing. If the called party answers this calling, the call is established and the calling timer is started immediately.

C. Use the headset

Press  Key, the LCD will show the current lines (user is able to switch from line1 to line6 by pressing the line key beside the LCD). Input the phone number and press soft key "**Send**" to dial the number. When caller hear the tones of "du~~du~~" and the phone number your dialed is being displayed on the LCD, the phone at the side of being called should be ringing. If the called party answers this calling, the call is established and the calling timer is started immediately.

D. Dial from phone book



1. Press  key to enter the menu and choose "**Contact**" option. Press "**Enter**" soft key and then find the contact person by navigation keys. When the certain contact person is highlighted, press "**Dial**" or just pick up the handset to call this number.
2. Pick up the handset, press "**Contact**" soft key, then find the contact person and press "**Dial**" soft key.
3. Pick up the handset, press  and enter "**Contact**", then find the contact person and press "**Dial**" soft key.

E. Dial from call history



1. Press  key to enter the menu and choose "**History**" option, then select one of call history entry, and press "**Dial**" soft key or pickup the handset to call this number.



2. Pickup the handset, press "**History**" soft key, then select one of call history entry, and press "**Dial**" soft key to call this number.
3. Pickup the handset, press  and enter "**Call History**", then select one of call history entry, and press "**Dial**" soft key to call this number.

2.3. Pre-dial

It's a method to dial a phone number immediacy at standby mode.

The method is as below:



A. Dial-up the phone number at standby mode

B. Press soft key "**Dial**" or Pick up the handset or Press  or  to send out the number.

2.4. Multiple line dial-up

D2SV supports up to 8 concurrent calls. If there is a new incoming call when you're talking on D2SV, the new incoming call will be displayed on LCD and status indicator LED will be fast blinking. User can press soft key "Hold" then press "Answer" to receive the new incoming call.

2.5. Call Hold

The current calling will be hold by pressing soft key "**Hold**" or , and the held call will be resumed after pressing soft key "**Resume**" or  or the corresponding line key. Even on 5-way conference calling, the conference will be held after pressing "**Hold**" key, and be resumed to 5-way conference after pressing "**Hold**" Key again. Remember the conversation is still on hold without being ended even if hung up under the status of hold.

2.6. Call Transfer

1. Attended call transfer

The attended transfer allows user to call a third-party before transferring the calling.

While calling, press the "**Transfer**" soft key to hold the current call and dial the target number you want to transfer to on the activated line and press "**Send**" soft key to call that number. After the target party answers the call, press "**Transfer**" soft key again to complete the transfer.

If the target number has been setup in the current BLF list, and you have already finished the necessary setup on Webpage of D2SV, there is an easier way to complete the attend transfer. While calling, press the corresponding BLF key of the target number and then press the "**Transfer**" soft key, the attend transfer will be achieved.

2. Blind call transfer

The blind transfer allows user to transfer a call without speaking to the third party. On the user side, the call will be ended as soon as the target phone number is dialed.

Operating steps: Press "More" soft key to get more option, then press "Bxfer" soft key, input the transfer target number and press "Send" soft key.

If the target number has been setup in the current BLF list, and you have already finished the necessary setup on Webpage of D2SV, there is an easier way to complete the Blind transfer. While calling, press the corresponding BLF key of the target number, the blind transfer will be achieved.

2.7. Mute calls

The input audio will be not transmitted to peer phone after pressing  key, and the phone will be muted even switched among different modes of speaker, handset and headset.

To un-mute, just press  key again.

2.8. 3-Way Conference

1. While on calling, press the soft key "**Conf**", input the 3rd party's phone number and then press the softkey "**Dial**" or press the soft key "**Conf**" and press the corresponding BLF key to invite the 3rd party to join a conference call.
2. After the third party answers the call, pressing "**Conf**" key again to establish the 3-way conference.



1. New call

- 1.1. While on the Conf call, the initiator can press the '**New call**' soft key to dial the call, then press the '**Conf**' soft key join the conf room;
- 1.2. Or when there is a new call incoming, answered the call, and press the 'Conf' soft key, the more can add 5-ways in the conf room.

2. Mute

- 2.1. While on the Conf call, the initiator can press the '**Mute**' soft key to forbidden the chosen conf member speak;
- 2.2. After '**Mute**', the initiator can press '**UnMute**' to recover the chosen ways speak.

3. More

- 3.1. While on the Conf call, the initiator can press '**More**' soft key to switch the first two keys feature.



4. Remove

4.1. While on the Conf call, the initiator can press the '**Remove**' soft key to remove the chosen conf member, the remove talking would be end the call.

4.2. If all the conf member be removed, the conf call would be ended.

5. Hold

5.1. While on the Conf call, the initiator can press the '**Hold**' soft key to hold the current conf call, and press the '**Resume**' would recover the call.

6. End

6.1. While on the Conf call, the initiator press the 'End' key can end the conf call.

2.9. Hang up the phone

1. Softkey hang up

While on calling, press the softkey "**End Call**" to hang up.

2. Handset hang up

Put back the handset at handset mode, the current calling will be hung up.

3. Speaker hang up

Press  key at speaker model, the current calling will be hung up.



4. Headset Hang up

Press  key at headset model, the current calling will be hung up.

5. Hang up one line call

Press the hook to hang up the current calling when 2 calls happened simultaneously.

2.10. Voicemail







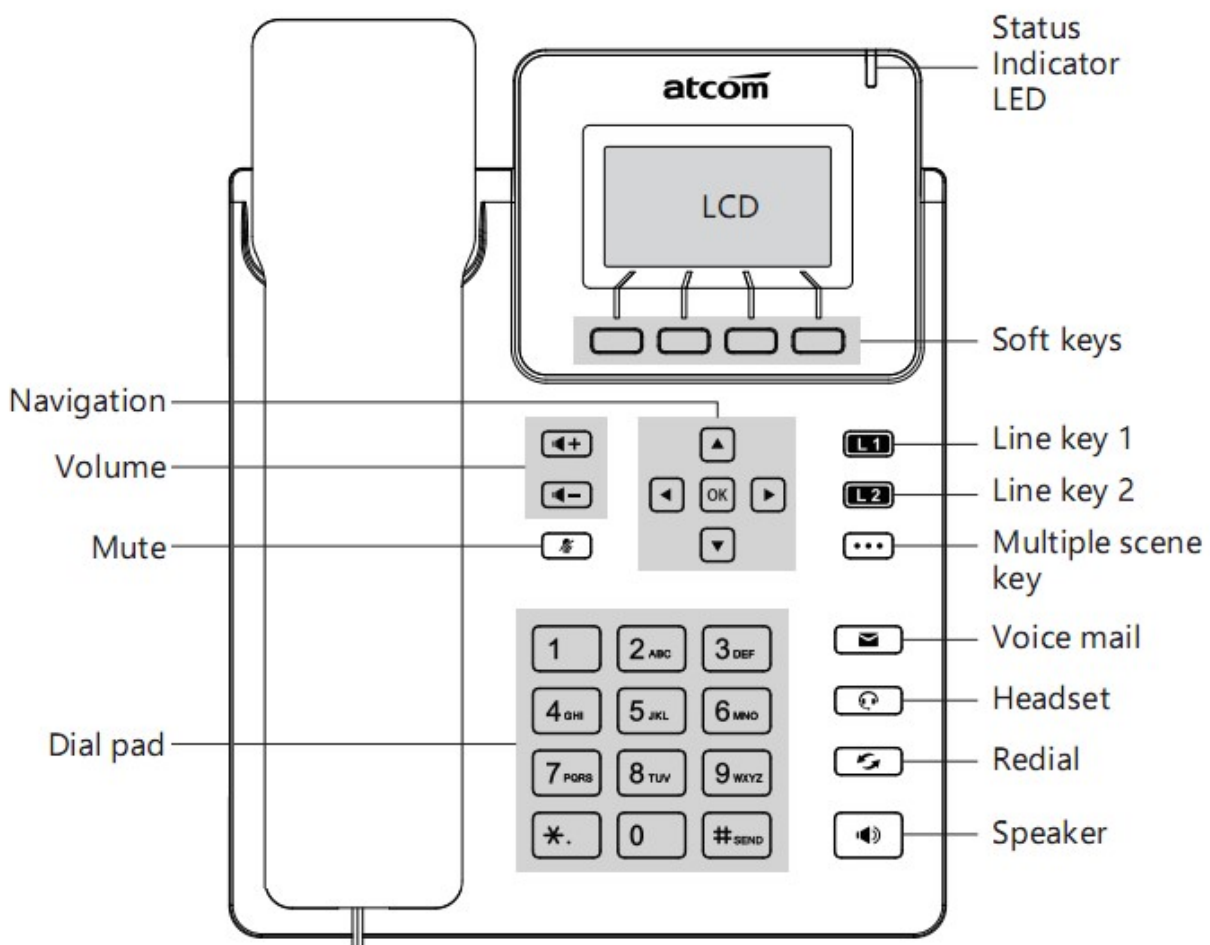

D2SV has a  key for entering voicemail box and indicating new voicemail. Press  key to enter the menu to configure voicemail number if you have never configured it previously. Otherwise, the voicemail number will be called after pressing it.





3. Keypad and GUI

3.1. Keypad

Description of the keys and Screen



| | |
|----------------------------------------------------------------------------------------------------------------------------------------------------------------------------|-------------------------------------------------------------------------------------------------------------------------------------------------------------------------------------------------------------------------------------------------------------------------------------------------------------------------------------------------------------|
| Soft Keys | <p>Press to select a function which displayed at the softkey zone of screen</p> <p>Display all optional functions at the last line of LCD screen.</p> |
| Status Indicator LED | <p>Indicates the phone's status,</p> <ul style="list-style-type: none"> ➤ If the phone is being started ,the LED is on ➤ If the phone is standby, the LED is off ➤ If there is income calling, the LED will blink at 120ms on, 120ms off. ➤ If there is a new message, the LED will blink at 600ms on, 600ms off. |
| LCD Screen | All information such as date, time, phone number, incoming caller's ID(if available), line/call status, extension numbers and the soft key features are displayed on it. |
| Dial pad | Entering numbers or characters. |
| Line Key | Shows extension number and status. |
| Navigation keys | <p>Allows users to navigate(left, right, up, down).Press  can enter "Directory". Press  can enter "History".</p> |
|   | Adjust the volume(speaker/handset/headset/ring). Volume level will be displayed on LCD when pressing volume key. |
|  | Confirm users' operation and show status when D2SV is idle. |
|  | Cancel users' operation. |
|  | Enter menu settings. |
|  | Pick up and hung up under the speaker mode. |
|  | <p>Mute the mic in a conversation by pressing the Mute button; this prevents the person on the active call from hearing what you or someone else in the room is saying.</p> <p>To un-mute, press the Mute button again.</p> |

| | |
|-----------------------------------------------------------------------------------|-----------------------------------------|
|  | Pick up and hung up under headset mode. |
|  | Check the Voicemail status. |
|  | Hold the current call. |
|  | Redial the last dialed number |

3.2. Starting

3.2.1. When start on the phone, it turns to standby status in about 50 seconds.

Welcome



3.2.2. After boot up finished, User can select the Language and time zone manually,





Note: If the **PIN code** is enabled on the SIM card, after entering the standby interface, you will be asked to enter the **PIN code**. According to the network service provide requirement: you need to enter the correct PIN code within three times. Otherwise, the card will be automatically locked and the **PUK code** will be prompted to unlock.





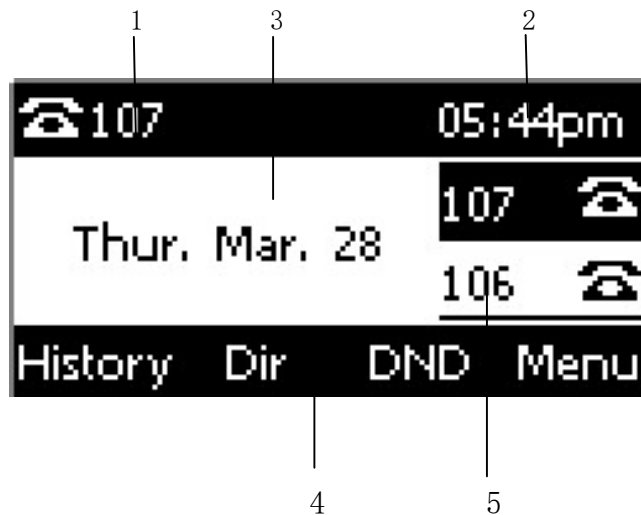









If the SIM card need input APN code, you can press **Menu** → **LTE setting** → **APN setting**, choose "Enable" custom APN, and press ↓ button to input APN account info.

3.3. Standby



| Area Item | Description |
|-----------|------------------------------------------|
| 1 | Status: to indicate the call status |
| 2 | Time |
| 3 | Softkey: "History", "Dir", "DND", "Menu" |
| 4 | Date |
| 5 | Line key |

Icon on Standby UI

| Icon | Description |
|-------------------------------------------------------------------------------------|---------------------------------------------|
|  | The account is registered successfully. |
|  | The account is not registered successfully. |
|  | The line is being occupied for dialing. |
|  | New incoming call |
|  | Call hold. |
|  | Unavailable Network. |
|  | Calling via handset |
|  | Calling via Speaker. |
|  | Calling via headset. |
|  | WiFi Signal indicator |
|  | Call Forward is activated. |
|  | New Voicemail. |
|  | Auto-Answer is activated. |
|  | DND is activated |
|  | 4G network Signal |

3.4. Configuration



Press the key  to enter the Main Menu:

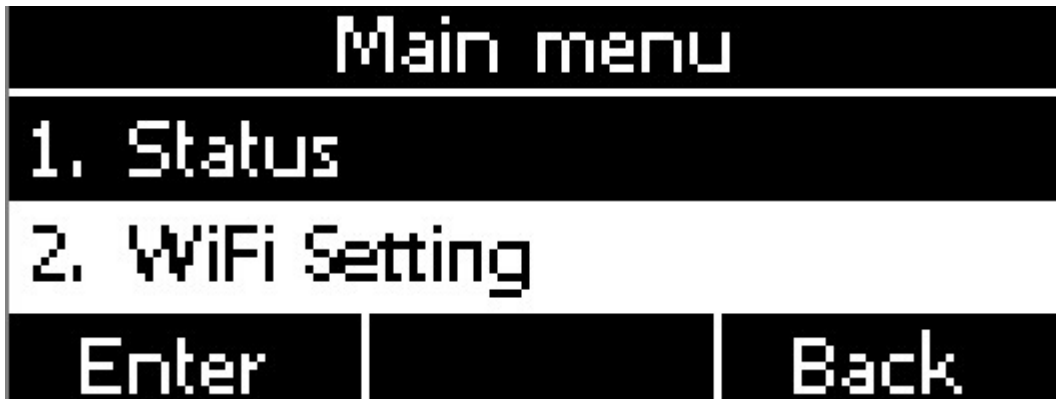

Move the navigation key and press the softkey **“Enter”** or input the corresponding Number key
Select the item of Main Menu:

| | |
|-----------------------|----------------------|
| Number Key “1” | Enter “Status” |
| Number Key “2” | Enter “WiFi Setting” |
| Number Key “3” | Enter “Feature” |
| Number Key “4” | Enter “Directory” |
| Number Key “5” | Enter “History” |
| Number Key “6” | Enter “Message” |
| Number Key “7” | Enter “Settings” |
| Number Key “8” | Enter “Display” |

3.4.1. Status info

It's able to check the status info via LCD Display or Web.

And the basic status and details status will be optional displayed on LCD display

1. Basic Status——IP address.MAC address. Firmware version.

2. Details Status—Network info. Production info and Account info in details.

Basic Status

You're able to check the basic status in both ways as below:

1. Press the key  on standby.

2. Press the key  and select the "Status" of Main Menu.

3. Move the navigation key, the status display the Model, IP, MAC, Firmware, More



Details Status

Select "**More**" and then press the softkey "**Enter**" to check details info, and move the navigation key to check more.

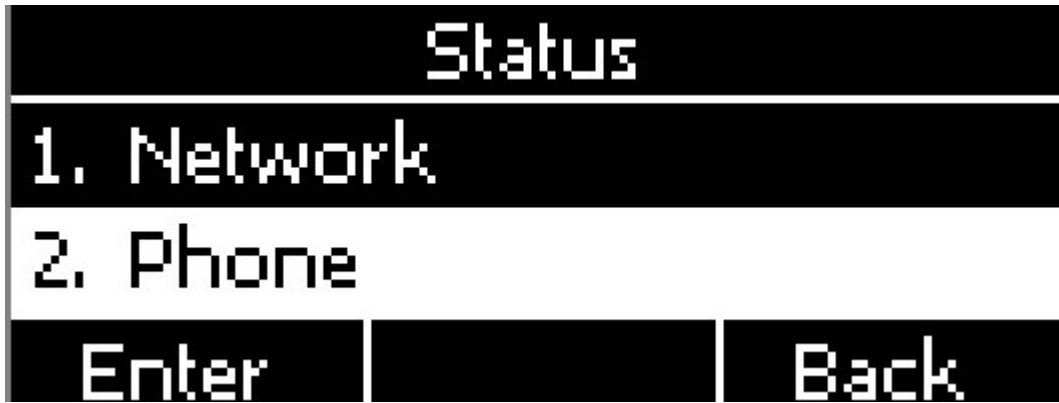

Press the softkey "**Enter**" to check status info, and "**Back**" to return the Basis Status page.

Check the Status info via Web

1. Check the IP address of IP phone;
2. Type the IP address on a web browser;
3. Input the username and password, the default user and password for Administrator is (admin, admin), for general user is (user, user), and then press "**Enter**".
4. By default, the Status info will be displayed.

3.4.2. Call Features

In this part, we will introduce the following content:

- [Call Forward](#)
- [Call Waiting](#)
- [Auto Answer](#)
- [DSS Keys](#)
- [Key as send](#)
- [Hotline](#)
- [Anonymous Calls](#)

1. Call Forward

"Call Forward" includes "Always Forward", "Busy Forward", "No Answer Forward".



"Always Forward" has the highest priority, and "Busy Forward" has the same priority as "No Answer Forward", that means once the function of "Always Forward" is activated, other call forward features will be unavailable.

Any type of Call forward feature is activated, the Icon  will be indicated on the LCD Display.

Always Forward

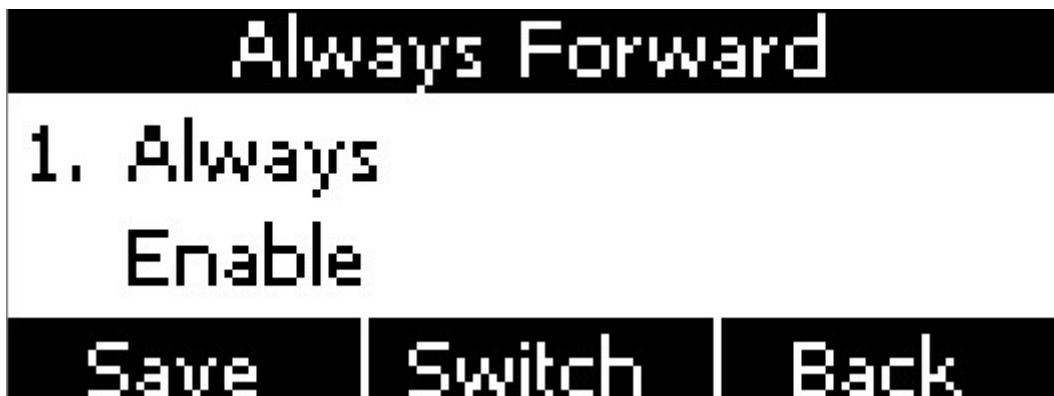
All incoming calls will be forwarded to target phone number once the "**Always Forward**" activated, setup this feature as follow and please move the navigation to check more:





| Item | Operation | Description |
|-------------------|----------------------------------------------------------------------------------------------------------------------------------------------------------------------------------------------------------------------------------|-----------------------------------------------------------------------------------------------------------------------------------------|
| Always | Press the key   or the soft key " Switch " to setup | Switch on or Switch off the feature. " Enable " mean this feature is enabled, " Disable " mean this feature is disabled. |
| Forward to | The Number key, "*"key, and "#"are permitted to be input. | Setup the target phone number which all incoming calls transferred to |
| On Code | The Number key, "*" key, and "#"are permitted to be input. | The feature code to enable all incoming calls forward, the phone will send the feature code directly to open all incoming calls forward |

| | | |
|-----------------|------------------------------------------------------------|-------------------------------------------------------------------------------------------------------------------------------------------|
| Off Code | The Number key, "*" key, and "# are permitted to be input. | The feature code to disable all incoming calls forward, the phone will send the feature code to close all incoming calls forward directly |
|-----------------|------------------------------------------------------------|-------------------------------------------------------------------------------------------------------------------------------------------|

Busy Forward

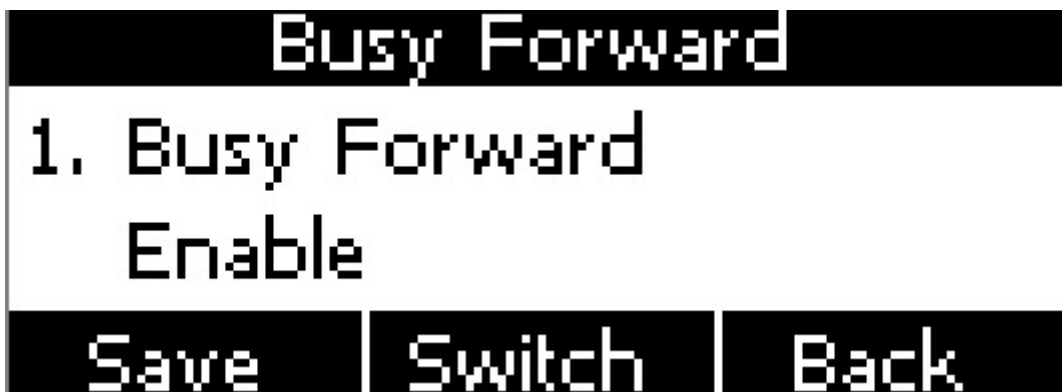
It means the phone is busy once the phone is not at standby mode. Setup this feature as below:





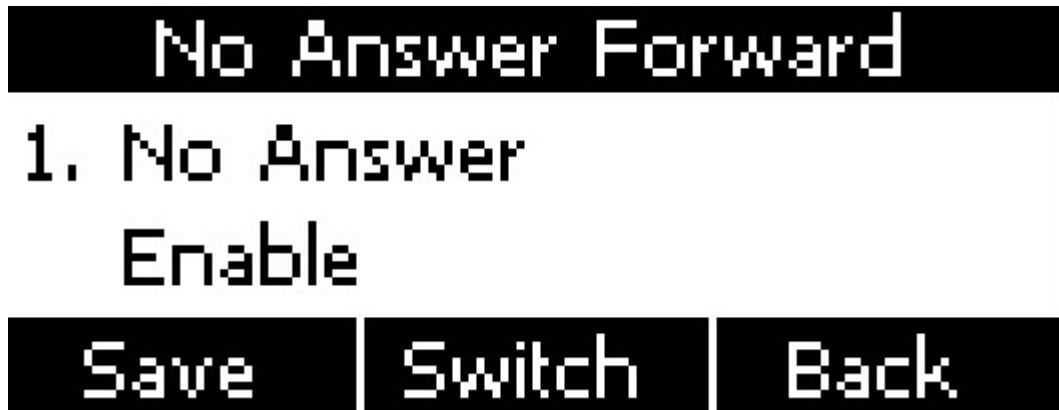

| Item | Operation | Description |
|-------------------|--------------------------------------------------------------------------------------------------------------------------------------------------------------------------------------------------------------------|----------------------------------------------------------------------------------------------------------------------------|
| Busy | Press the key   or softkey "Switch" to setup | Switch on or Switch off the feature. "Enable" mean this feature is enabled, "Disable" mean this feature is disabled. |
| Forward to | The Number key, "*" key, and "# are permitted to be input. | Setup the target phone number which all incoming calls transferred to |
| On Code | The Number key, "*" key, and "# are permitted to be input. | The feature code to enable busy calls forward, the phone will send the feature code directly to open busy call forward |
| Off Code | The Number key, "*" key, and "# are permitted to be input. | The feature code to disable busy calls forward, the phone will send the feature code directly to close busy call forward |

No Answer Forward

All incoming calls will be forwarded after time out, once the feature of “No Answer Forward” is activated. Setup this feature as below, and please move the navigation key to check more:



| Item | Operation | Description |
|------------------------|-----------------------------------------------------------------------------------------------------------------------------------------------------------------------------------------------------------------------------|-------------------------------------------------------------------------------------------------------------------------------------------|
| No Answer | Press the key   or softkey “ Switch ” to setup | Switch on or Switch off the feature. “ On ” mean this feature is activated, “ Off ” mean this feature is unactivated . |
| Forward to | The Number key, “*” key, and “#” are permitted to be input. | Setup the target phone number which all incoming calls transferred to |
| After Ring Time | Press the key   or softkey “ Switch ” to setup | Setup timer for no answer status. All incoming calls will be forwarded after time out once Call forward when no answer activated. |
| On Code | The Number key, “*” key, and “#” are permitted to be input. | The feature code to enable no answer call forward, the phone will send the feature code directly to open all incoming calls forward |
| Off Code | The Number key, “*” key, and “#” are permitted to be input. | The feature code to disable all incoming calls forward, the phone will send the feature code directly to close all incoming calls forward |

Setup Call Forward Via Web

Set Call Forward via web: **Phone**→**Features**→**Forward**.

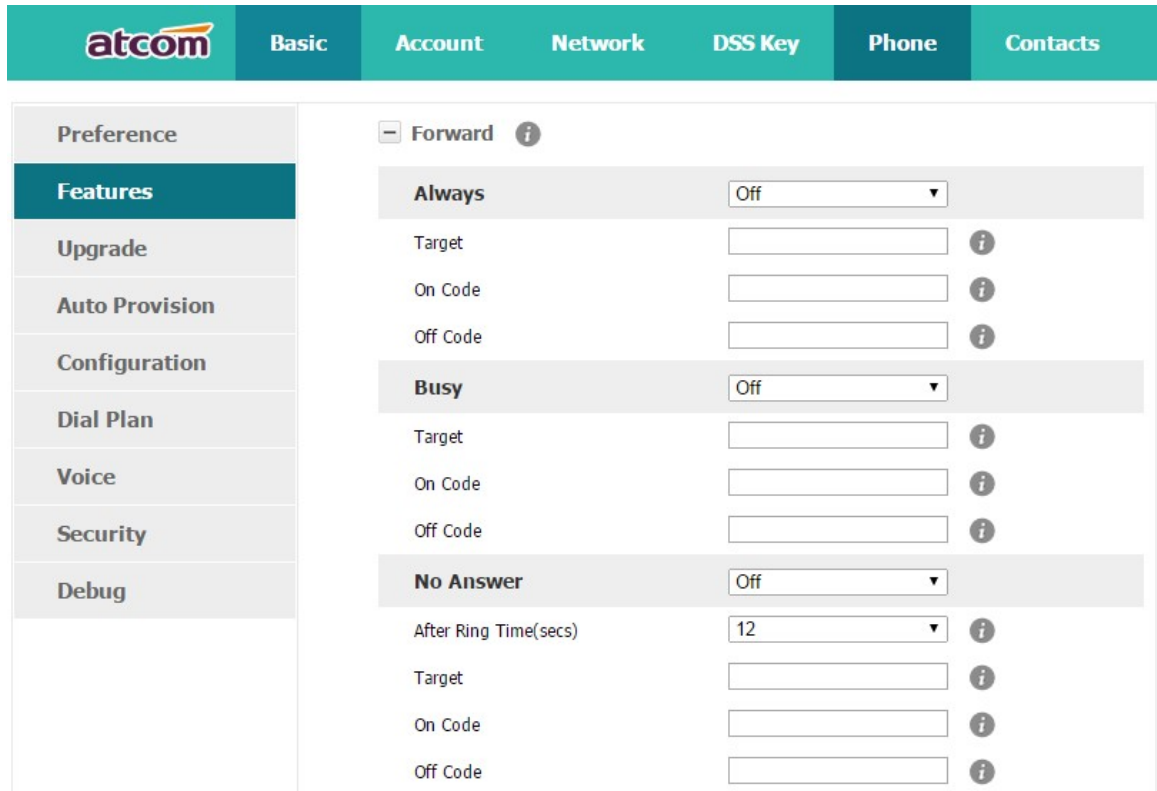

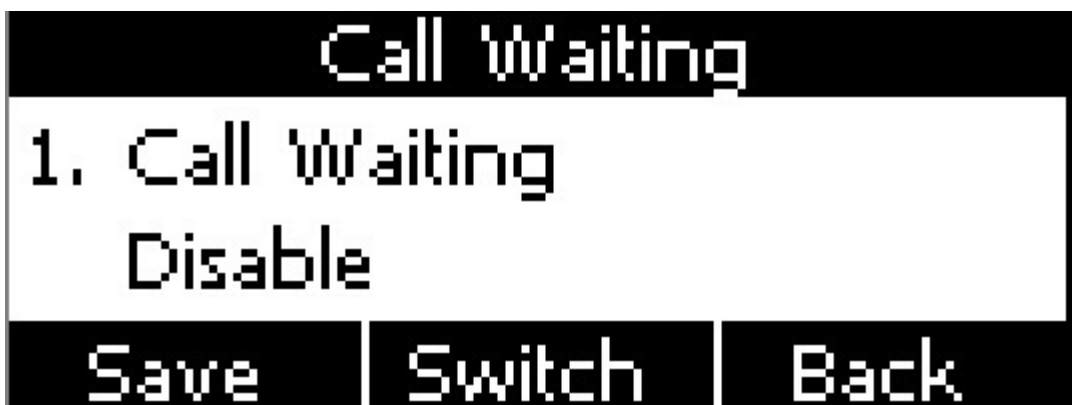

2. Call Waiting

The feature of “Call Waiting” is available by default. If switch off this feature, whatever multiple SIP accounts had been registered successfully, only one single active calling is permitted (for example Dialing, Ringing, Calling, Holding).



| Item | Operation | Description |
|---------------------|----------------------|--------------------------------------|
| Call Waiting | Press the key . or | Switch on or Switch off the feature. |

| | | |
|--------------------------|-----------------------------------------------------------------------------------------------------------------------------------------------------------------------------------------------------------------------|--------------------------------------------------------------------------------------------------------------------------------------------|
| | softkey "Switch" to setup | "Enable" mean this feature is enabled, "Disable" mean this feature is disabled. |
| Call Waiting Tone | Press the key   or softkey "Switch" to setup | Switch on or Switch off the prompt playing. "Enable" mean this feature is enabled, "Disable" mean this feature is disabled . |

Setup call waiting via web: **"Phone"**→ **"Feature"**→ **"General information"**→ **"Call Waiting"**.

Setup call waiting Tone via web: **"Phone"**→ **"Feature"**→ **"Audio Settings"**→ **"Call Waiting Tone"**.

3. Auto Answer

The feature of "Auto Answer" is switched off by default. All incoming calls will be answered automatically when the phone is standby once "Auto Answer" is activated. "Auto Answer" when the phone is under "on Calling" status.

Please move the navigation key to check more:

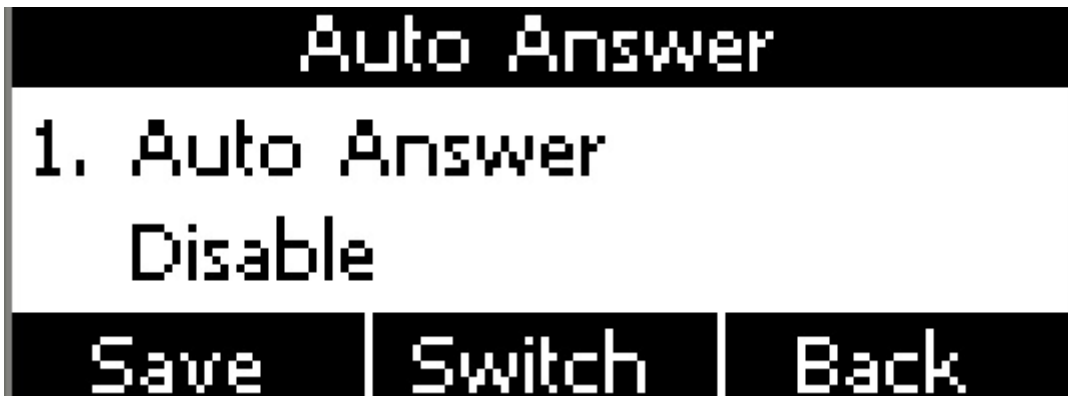

The Icon  will be indicated once "Auto Answer" is available.

Setup "Auto Answer" via Web: **"Phone"**→ **"Feature"**→ **"General information"**→ **"Auto Answer"**

4. DSS Keys

The programmable keys include Line keys, Programmable keys and Soft keys on Standby UI.

it is able to modify the feature of each programmable key.

All programmable keys has been classified as "N/A", "Line Key", "BLF", "Key event", "Speed dial", "Intercom"

And the "Key Event" has been classified as "Conference", "Hold" "DND", "Redial", "Call return", "Pickup", "Call Park", "DTMF", "Directory".

Comments:



N/A

N/A means this key is not permitted to be set as a programmable key.

Line key

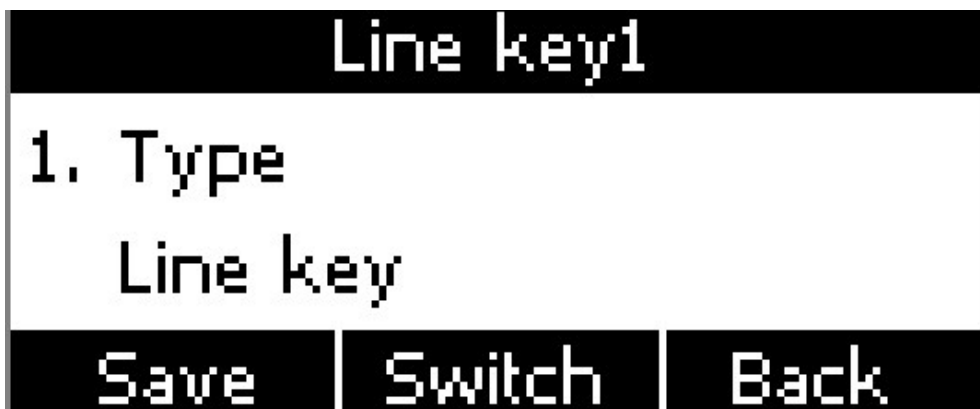
Display the account information, press it for making a call, answering incoming calls, call hold and resume.





| Item | Description |
|---------------------|-----------------------------------------------------------------------------------------------------------------------------------------------------------------------------------------------------------------------------------------------------------------------------------------------|
| Account ID | To display the account ID, press the soft key " Switch " or  、  to modify, the optional value is Account 1 to 4. |
| Account name | Display the account name of each account ID, non-modifiable. |
| SIP Server | The SIP server of each Account ID, non-modifiable. If not set any value for some account ID, the account name will be null. |

BLF

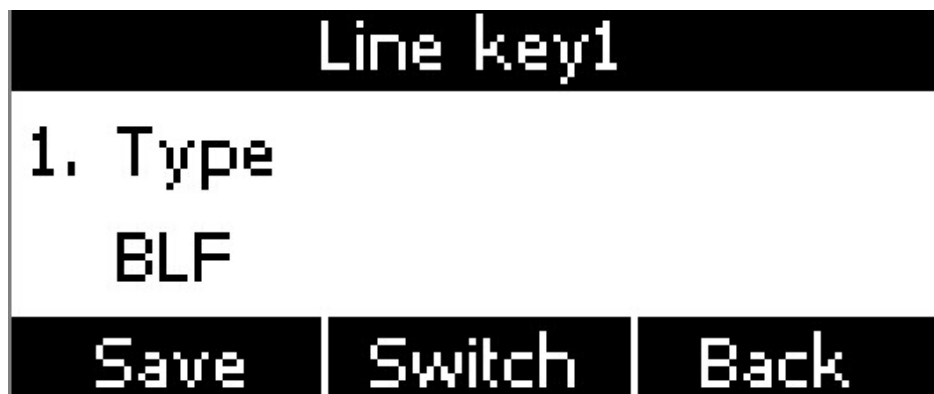
Indicate the status of monitored account. Once set the BLF key with Pickup feature, user is able to answer the incoming call to the monitored account by pressing the corresponding BLF key. If the monitored account is idle, press the corresponding BLF key for speed dial.



| Item | Description |
|-------------------|---------------------------------------------------------------------------------------------------------------------------------------------------------------------------------------------------------------------------------------------------------------------------------------------------|
| Account ID | To display the account ID, press the soft key " Switch " or  、  to modify, the optional value is Account 1 to 2. |
| Label | To identify this key on LED, for example "blf" |
| Value | The phone number will be monitored by this key. For example, if user want to monitor the phone number (5003), please set "6070" here. |
| Extension | This code must be configured for pickup, and this code provide by Server. If the code is not matched by Server, the feature of pickup will not work. |

Conference

The 3-way conference will be setup by pressing the key "Conf" while on calling. For more info, please refer to [Chapter 3.8](#).

The configuration item **Label** is a name to identify the key on LED, can be set as "conference".

Hold

The same feature as the key . For more info, please refer to [Chapter 3.5](#).

The configuration item **Label** is a name to identify the key on LED, can be set as "hold".

DND

Press this key will switch on or switch off the feature of "DND".

The configuration item **Label** is a name to identify the key on LED, can be set as "DND".

Redial

The same feature as the key .

The configuration item **Label** is a name to identify the key on LED, can be set as "redial".

Call return

Automatically dial the latest phone number in history.

The configuration item **Label** is a name to identify the key on LED, can be set as "return".

Call Pickup

Press this key to pick up if new incoming call to the monitored phone number.

| Item | Description |
|--------------|---------------------------------------|
| Value | The phone number monitored for pickup |
| Label | A2X cannot definition label |

Reminding: This code must be set for pickup, and this code can be set via Web only.

Set the Pickup code as follow:

Set the pickup code for one single Account: **Account**→**Advanced**→**Select an account to be configured**→**Directed Call Pickup Code**.

Set the pickup code for all Accounts: **Phone**→**Features**→**Call Pickup**→**Direct Call Pickup**.
Direct Call Pickup Code (Direct Call Pickup should be set as Enable) .

Call Park

Press this key while on calling, the phone will dial the specified phone number, user will receive a code on the phone prompt, and then press the soft key "Transfer", the current calling will be parked successfully. At this moment, user is able to continue the parked calling with any other phones which registered on the same SIP server by dialing the code which user have received.

| Item | Description |
|--------------|-----------------------------------------------------------------------|
| Value | The code for pickup the parked call and it is provided by SIP server. |
| Label | A2X cannot definition label |

DTMF

Press this key while on calling, the phone will send the configured "**Value**" automatically.

| Item | Description |
|--------------|------------------------------------------------|
| Value | The value sent to remote end while on calling. |
| Label | A2X cannot definition label |

Directory

Press this key to access Directory.

Speed Dial

Press this key while standby state, the specified target phone number will be dial from the specified account.

| Item | Description |
|--------------|----------------------------------------|
| Value | The target phone number for speed dial |
| Label | A2X cannot definition label |

Intercom

Press this key when the phone is idle, the phone will dial the specified "Value", and there mote end will answer the call automatically.

Note: This feature is supported by specified servers only.

| Item | Description |
|--------------|--------------------------------------|
| Value | The target phone number for Intercom |
| Label | A2X cannot definition label |

| atcom | | | | | |
|------------------------------------------------------------------------------|--------|---------|-------|-------------|-----------|
| Basic | | Account | | Network | |
| DSS Keys | | Phone | | Contacts | |
| Line Keys | | | | | |
| Programmable Keys | | | | | |
| Key | Type | Value | Label | Account | Extension |
| Line Key1 | Line ▼ | | | Account 1 ▼ | |
| Line Key2 | Line ▼ | | | Account 2 ▼ | |
| <input type="button" value="Confirm"/> <input type="button" value="Cancel"/> | | | | | |

5. Key as Send

The key "Key as Send" has the same function as the soft key "Dial".

Reminding: This key is not available while pre-dial. It's the only way to press the soft key "Dial" or pickup the handset to finish pre-dial.

The default value is "#", and it could be set as "*". If set the value as "disable", it means the function "Key as Send" is forbidden.

Set "Key as Send" via web : **Phone**→**Features**→**General Information**→**Key As Send**.

6. Hotline

Once "Hotline" has been set, the phone will automatically dial the hotline via the 1st available line if the phone stay in the standby status exceed the specified waiting time and there is no input (or input something and then all deleted).



| Item | Description |
|------------------------|------------------------------------------------------------------|
| Hotline | Set up the hotline number, the value is null by default. |
| Hotline timeout | Set up the timeout for hotline activation, 4 seconds by default. |

Set hotline via web: **Phone**→**Features**→**General Information**→**Hotline**.

Set Hotline Time-out(secs) via web: **Phone**→**Features**→**General Information**→**Hotline Time-out(secs)**.

7. Anonymous Call





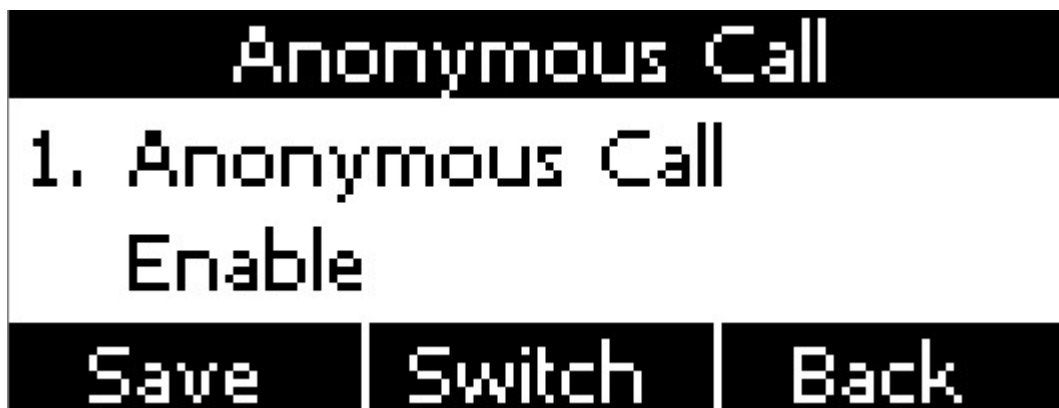

This function includes making anonymous calls and blocking all anonymous calls.

If switch on the feature "Anonymous call", all outgoing calls will be displayed as anonymous call in the remote end.

If switch on the feature "Rejection", all incoming anonymous calls will be blocked automatically.

please move the navigation key to check more:



| Item | Operation | Description |
|------------------------|--------------------------------------------------------------------------------------------------------------------------------------------------------------------------------------------------------------------|-----------------------------------------------------------------------------------------------------------------------------------------------------|
| Accounts | press the soft key "Switch" or  .  to modify, | Select the Account for anonymous call. |
| Anonymous Call | press the soft key "Switch" or  .  to modify, | Switch on/off the feature of making anonymous calls. |
| Call On Code | The Number key, "*" key, and "#" are permitted to be input. | Set the feature code to turning on anonymous call, the phone enables anonymous call by sending the feature code to the server |
| Call Off Code | The Number key, "*" key, and "#" are permitted to be input. | Set the feature code to turning off anonymous call, the phone disables anonymous call by sending the feature code to the server |
| Rejection | press the soft key "Switch" or  .  to modify | Switch on/off the feature of blocking anonymous calls. |
| Reject On Code | The Number key, "*" key, and "#" are permitted to be input. | Set the feature code to turning on anonymous call rejection, the phone enables anonymous call rejection by sending the feature code to the server |
| Reject Off Code | The Number key, "*" key, and "#" are permitted to be input. | Set the feature code to turning off anonymous call rejection, the phone disables anonymous call rejection by sending the feature code to the server |

Set Anonymous Call via web: **Account**→**Basic**→**Select the Account**→**Anonymous Call**.

Set Anonymous Call Rejection via web: **Account**→**Basic**→**Select the Account**→**Anonymous Call Rejection**.

3.4.3. Contacts

The content of Directory includes local phonebook and blacklist. Enter Directory as follow,

1. Press the soft key "Contacts" when the phone is standby

2. Press the navigation key 

3. Press the menu key , and then select "Contacts"

Configure the "Contacts" via Web:

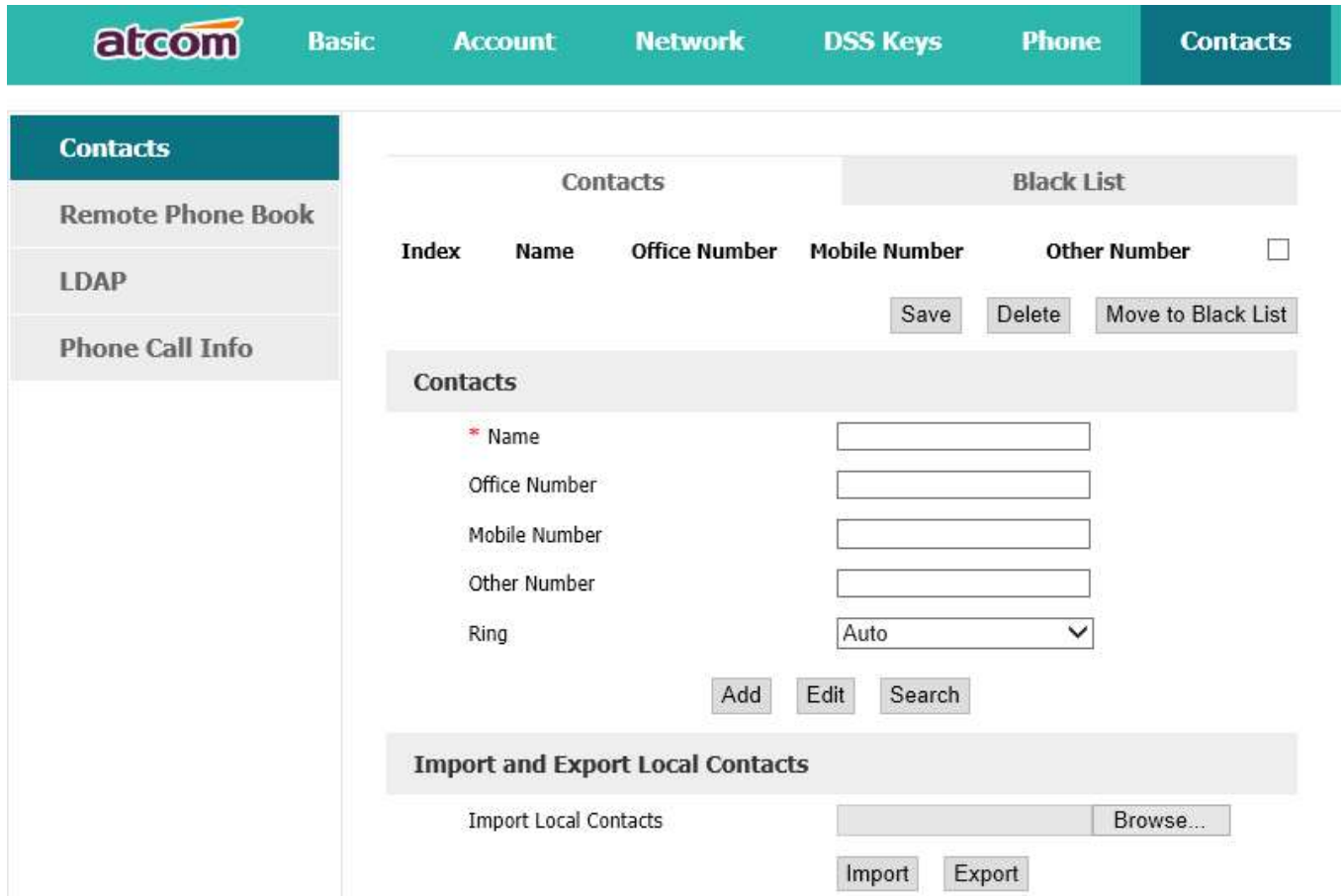

All operations on Directory via Web will be not active until click "Save". When too much item existed in the Directory, it will be an easy way to search by keyword about name, Office Number, Mobile Number or other Number. The exactly matched item will be listed, otherwise you will be prompted "Not find the specified contact".

Local Contacts



Name and phone number are permitted to be saved into the local phonebook, and up to 400 items. It's able to add new group, new contact, edit or delete exist contact or dial, also move the item to blacklist.

Make calls from directory



Path to set on the phone: **→Contacts→Local Contacts→All contact→ Select the record→Dial.**

If only one phone number saved with the selected contact person, the phone number will be dialed while calling the contact person.

If multiple phone numbers saved with the selected contact person, user must select one of the phone numbers for dialing while calling the contact person.

Add new contact



Path to add new contact on the phone: **Press →Contacts→Local Contacts→All contact →Add.**



| Item | Operation | Description |
|---------------|------------------------------------------------------------------------------------------------------------------------------------------------------|-------------------------------------------------------------------------------------------------------------------------------------------------------------------------------------------------------------------------------------------------------------------|
| Name | Input by number keys, "*" or "#" key, change the input-method via pressing the soft key "abc" | It's used to identify different phone numbers. Any reduplicated names are not permitted in the contacts. |
| Office | Input by number keys, "*" or "#" key, change the input-method via pressing the soft key "abc" | You can save three numbers at most. While calling a contact person in contacts, the phone will redirect to the page that to select one number to dial when multiple numbers are saved for one contact record |
| Mobile | | |
| Other | | |
| Ring | Press the key  or the soft key "Switch" to modify the account ID. | It's used to bundle each item with the corresponding ringtone, and the optional value is "Auto" or "Ringtone 1" to "Ringtone 10". "Auto" means the default ringtone will be played if new incoming call happened, otherwise the selected ringtone will be played. |

Add new contact via web: **Contacts**→ **Contacts**→**Input messages**→**Add**→**Save**.

Edit the contact

User must re-edit the contact item while updating one item of local phonebook.



Path to edit the contact on the phone: **Press**  → **Contacts**→**Local Contacts**→**All contacts** → **Select the item to edit**→**Option**→**Edit**→**OK**.



Edit the contact item via Web: **Contacts**→ **Contacts**→click on the item to edit→modify messages→Click "Edit"→Click "Save".

Delete the contact



Path to delete the contact on the phone: Press  →**Contacts**→**Local Contacts**→**All contacts**→**Select the item to delete**→**Option**→**Delete**→ **OK**→**OK**.

Press the soft key "Cancel" at the Warning UI to stop deleting.

Delete the contact item via web: **Contacts**→ **Contacts**→**Select the item to delete**→Click on "Delete"→Click on "Save".

Move to blacklist

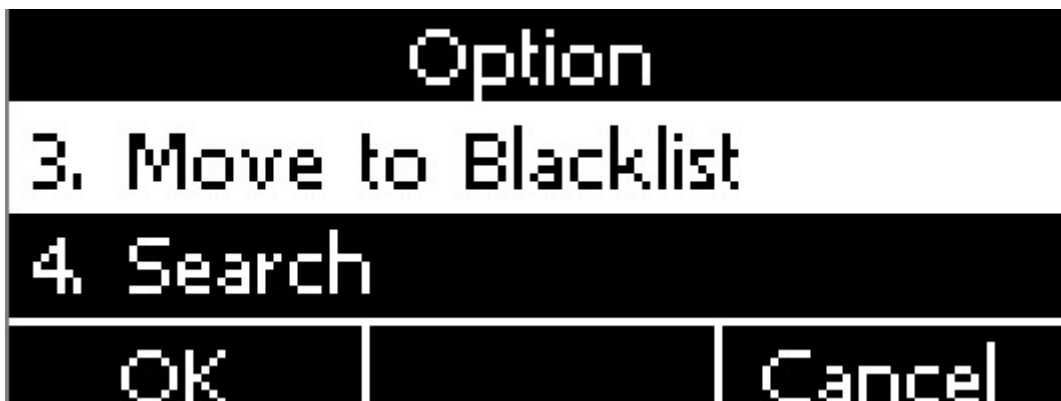

Path to move to blacklist on the phone: Press  →**Contacts**→**Local Contacts**→**All contacts**→**Select the item to move**→**Option** →**Move to Blacklist** → **OK**→**OK**.

Press the soft key **“Cancel”** at the Warning UI to stop this operation.

Move the contact item to blacklist via web : **Contacts**→ **Contacts**→**Select the item to move to blacklist**→**Click on “Move to black List”**→**Click on “Save”**.

Blacklist

The purpose of blacklist’s feature is to block the phone number inside blacklist to call the host phone number, but it’s available for the hosted phone number to call any phone number in the black list.

The most operation of blacklist is the same as local phonebook except for the feature “Move to Contacts”, it means moving an item of blacklist to local phonebook to resume the phone number to dial the host phone number normally.

Remote phonebook

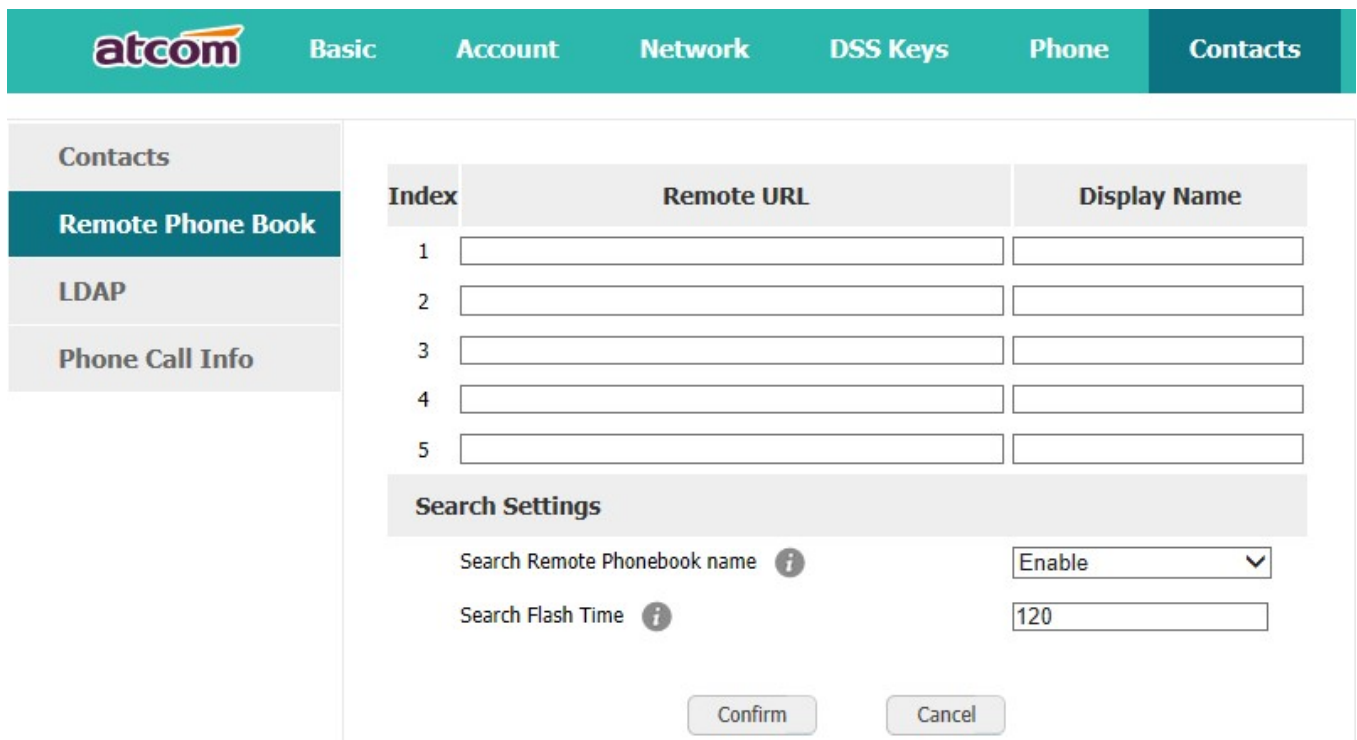

| Index | Remote URL | Display Name |
|-------|----------------------|----------------------|
| 1 | <input type="text"/> | <input type="text"/> |
| 2 | <input type="text"/> | <input type="text"/> |
| 3 | <input type="text"/> | <input type="text"/> |
| 4 | <input type="text"/> | <input type="text"/> |
| 5 | <input type="text"/> | <input type="text"/> |

Search Settings

Search Remote Phonebook name i

Search Flash Time i



















1. Remote URL: Set a remote phonebook download path. Support the TFTP,FTP,HTTP and HTTPs server.

2. Display name: Set a display name on the phone.

3. Search Remote Phonebook name: Select "Yes" or "No" to enable or disable search remote phonebook name.

4. Search Flash Time: Set the search flash time. Defaults to 120.

LDAP

| LDAP  | |
|----------------------------------------------------------------------------------------|-----------------------------------------------------------------------------------------------------------------------------------------------------------------------------------------------------------------|
| Enable LDAP | <input type="text" value="Disable"/>  |
| LDAP Name Filter | <input type="text"/>  |
| LDAP Number Filter | <input type="text"/>  |
| Server Address | <input type="text"/> Port <input type="text" value="389"/>  |
| Base | <input type="text"/>  |
| Username | <input type="text"/>  |
| Password | <input type="text"/>  |
| Max Hits | <input type="text" value="50"/>  (1~32000) |
| LDAP Name Attributes | <input type="text"/>  |
| LDAP Number Attributes | <input type="text"/>  |
| LDAP Display Name | <input type="text"/>  |
| Protocol | <input type="text" value="Version 3"/>  |
| LDAP Sorting Results | <input type="text" value="Disable"/>   |
| LDAP Lookup For Incoming Call | <input type="text" value="Disable"/>   |
| LDAP Lookup For dialing | <input type="text" value="Disable"/>   |

1. Enable LDAP: Select "Yes" or "No" to enable or disable LDAP.
2. LDAP Name Filter: Set the name of the LDAP search attributes.
3. LDAP Number Filter: Set the number of the LDAP search attributes.
4. Server Address: Set the LDAP server domain name or IP address.
5. Port: Set the LDAP server port number. Default to 389.

6. Base: Set the LDAP search base.
7. Username: Set the LDAP server username.
8. Password: Set the LDAP server password.
9. Max Hits(1~32000): Set the maximum number of search results from the LDAP server.
10. LDAP Name Attributes: Set the name of the attributes returned from the server.
11. LDAP Number Attributes: Set the number of the attributes returned from the server.
12. LDAP Display Name: The contact record the name of the displayed on the LCD.
13. Protocol: Set the phone to support LDAP protocol version. Defaults to version 3.
14. LDAP Sorting Results: Set the phone to sort the search results.
15. LDAP Lookup For Incoming Call: Set the phone for LDAP search when incoming call.
16. LDAP Lookup For dialing: Set the phone for LDAP search when dialing,

3.4.4. History

It includes the dialed, answered, missed and transferred items, maximum 400 items.

User is able to review or delete any item of the history on the phone. And enter "History" in below ways:

1. Press the key 
2. Press the key , then select "History"
3. Press the soft key "History" while phone is under standby status

When any operations above is done, details info of all recent history will be listed on LCD display, include the type of each item, the name of contact person, date and time.

Also, user is able to check the detail info of call history via Web, but only review operation is allowed while accessing via web.

| atcom | | | | | | |
|-------------------|-----------------|------------------------|------|-------------------|--|----------------|
| Basic | | Account | | Network | | |
| DSS Keys | | Phone | | Contacts | | |
| Contacts | | Dialed List | | | | Missed List |
| Remote Phone Book | | Received List | | | | Forwarded List |
| LDAP | | | | | | |
| Phone Call Info | | | | | | |
| Index | Datetime | Local Identity | Name | Tel Number | | |
| 1 | 2016/1/13 10:46 | 5030@172.16.0.240:5060 | 5001 | 5001@172.16.0.240 | | |
| 2 | 2016/1/13 10:45 | 5030@172.16.0.240:5060 | 5031 | 5031@172.16.0.240 | | |
| 3 | 2016/1/13 10:45 | 5030@172.16.0.240:5060 | 5002 | 5002@172.16.0.240 | | |

Make calls from history

Path to make calls from history on the phone: **Enter history UI**→**Select the item to dial**→**Dial**.

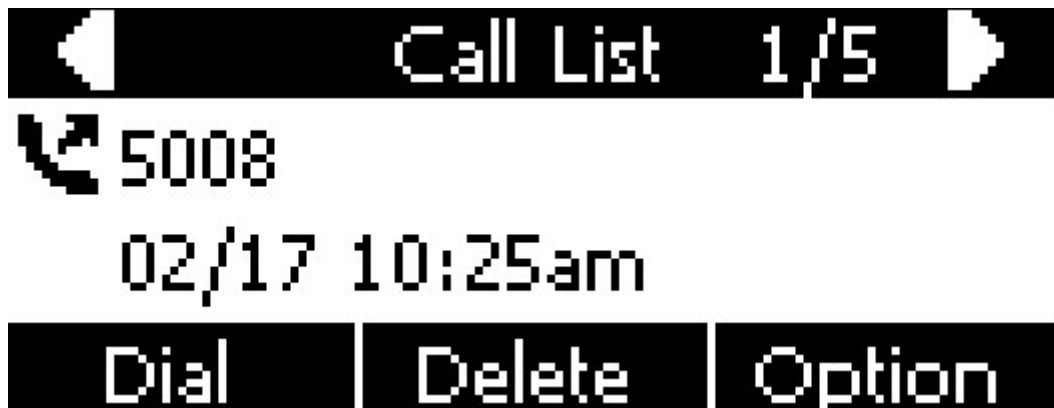

Delete one item from history

Path to delete one item from history on the phone: **Enter history UI**→**Select the item to delete**→**Delete**.

Check the details of history

Path to check the details of history on the phone: **Enter history UI**→**Select the item to check**→**Option**→**Detail**→Press  or "OK".



Add to Contact

1. **Enter "Call History"**→**Select the target item**→**Option**→**add to Contact**→**Press the key**  **or soft key "Confirm"**.

At this moment an "edit" page will be popped up.

Please move the navigation key to check more

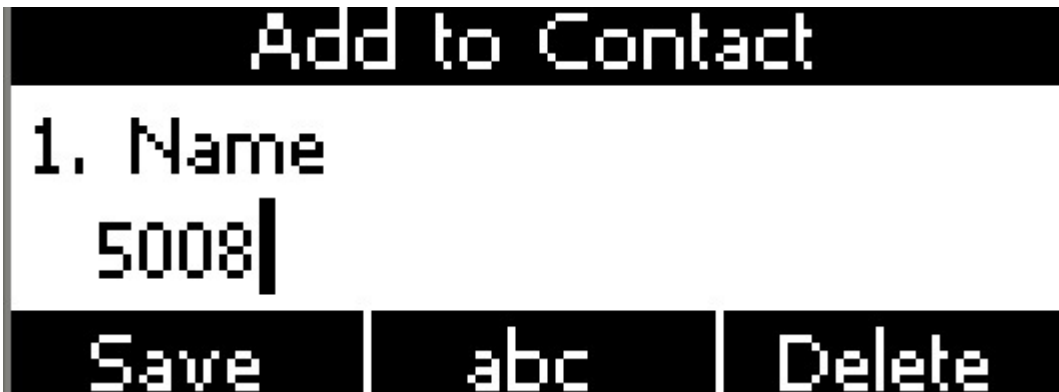

The item of "Office", "Mobile" and "Other" are able to be switched over between "Old Number" and current number. If the being operated item had been saved already in the contacts, "Old Number" will be the previous value, otherwise "Old Number" will be null. The UI page of "Add to Blacklist" is the same as above.

2. **Modify the contact name, phone number and ringtone.**

3. **Press the key**  **or soft key "Saved" to save the modification, press the key** 

or soft key “Cancel” to Cancel the modification.

Add to Blacklist

For more info about this operation, please refer to [Add to Contact](#).

Delete all History’s records

Path to delete all history’s records on the phone: **Enter History UI**→**Option**→**Delete all**→

Press  or “OK”.

3.4.5. Message

User will benefit from the feature of voicemail when they’re not available to answer an incoming call or missed some incoming calls. However this feature must be supported by Server. Voicemail must be set up before using it.

Set the voicemail via Web: **Account**→**Basic**→**Select an account to configure**→**Voice Mail**.

Sometimes the voicemail push can’t be reached in time, because the configuration problem with Server, you must configure some related parameter via Web to make the phone automatically send its request to Server for getting voicemail info.

Set “Subscribe for MWI” via web: **Account**→**Advanced**→**Subscribe for MWI**.

Set “MWI Subscription Period(secs)” via web: **Account**→**Advanced**→**MWI Subscription Period(secs)**.

Set Voice Mail

There are 3 different methods to set up the voicemail,

1. Press the key  after factory set

2. Press the key  for a while



3. Press the key →Select "Message"→Setup Voicemail



View Voice Mail

User is able to check voicemail in below ways:

1. Setup voicemail number→Press the key



2. Press the key →Select "Message"→"View Voicemail"

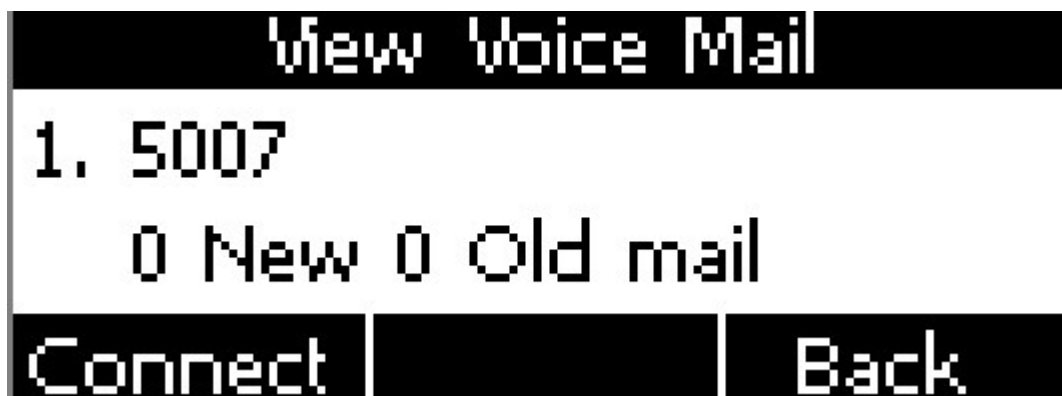

Select the account with "N new N old mail", and press the soft key "Connect", the corresponding voicemail will be connected.

Select the account with "Unregistered", and press the soft key "Connect", the setting page of Voicemail will be popped up.

3.4.6. Settings

Basic settings and Advanced settings will be introduced in this part,

Basic Settings



1. Language

D2SV supports multiple language, to modify the language, please press the key  → **Setting** → **Basic setting** → **Language** → **Select the target language and press the soft key "Save"**.



Set language via web: There is a drop-down box at the top left corner of webpage, choice one kind of language and click, the language will take effect immediately.

| atcom | | Basic | Account | Network | DSS Keys | Phone | Contacts |
|---------------|------------------|-------------|---------|---------|----------|-------|----------|
| Status | Version ⓘ | | | | | | |
| Wizard | Model | A10W | | | | | |
| | Firmware Version | 2.2.0.99716 | | | | | |
| | Hardware Version | 1 | | | | | |

2. Time & Date

Time & Date will be displayed at the standby page of D2SV, and these info will be related with all process of IP phone. "Time & Date" can be gained by NTP Server automatically or set manually.





NTP Setting



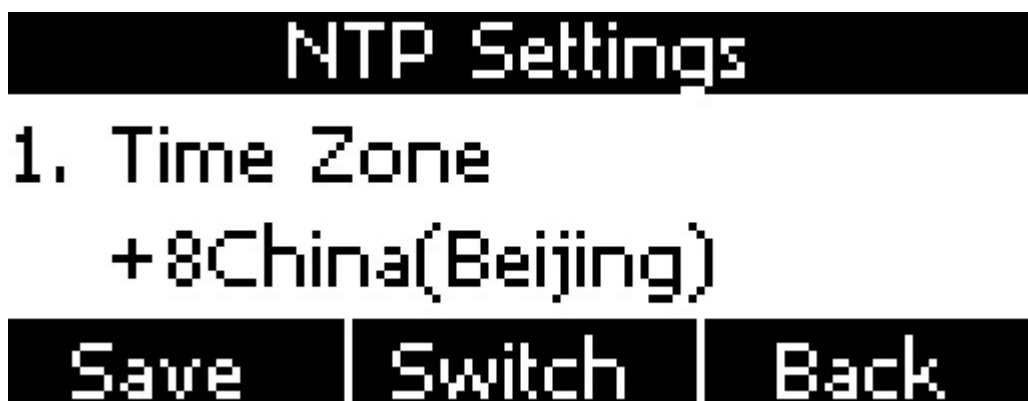

Path to set on the phone: **Press**  → **Settings** → **Basic Settings** → **Time & Date** → **NTP Settings**.

Please move the navigation key to check more:



| Item | Operation | Description |
|-----------------------------|----------------------------------------------------------------------------------------------------------------------------------------------------------------------------------------------------------------------|------------------------------------------------------------------------------------|
| Time Zone | Press the key   or soft key "Switch" to modify it. | Select the correct Time Zone for the IP phone. |
| NTP Server | Key in the IP address of domain name by the number keys, "*", "#" | Specify the NTP Server |
| Secondary NTP Server | Key in the IP address of domain name by the number keys, "*", "#" | Specify the standby NTP Server |
| Daylight-Saving Time | Press the key   or soft key "Switch" to modify it. | Optional: "Off", "Auto" or "Manual". And "Manual" mean user must set this via web. |

Set NTP via Web: **Phone**→**Preference**.

| | | |
|-----------------------|------------------------------------------------------------------------|---------------------------------------------------------------------------------------|
| Time Zone | +8 China(Beijing) ▼ |  |
| Primary NTP Server | pool.ntp.org | |
| Secondary NTP Server | time.windows.com | |
| Update Interval(secs) | 1000 |  |
| daylight | Disable ▼ |  |
| Fixed Type | <input checked="" type="radio"/> By Date <input type="radio"/> By Week | |
| Start Month | January ▼ | |
| Start Date | 1 | |
| Start Hour of Day | 0 | |
| Start Day of Week | Sunday ▼ | |
| Start Week of Month | First In Month ▼ | |
| Stop Month | January ▼ | |
| Stop Date | 1 | |
| Stop Hour of Day | 0 | |
| Stop Day of Week | Sunday ▼ | |
| Stop Week of Month | First In Month ▼ | |
| Offset(minutes) | 0 | |

| Item | Operation | Description |
|------------------------------|-------------------------------|---------------------------------------------------------------------------|
| Time Zone | Click drop-down box to select | Set a time zone matches condition |
| Primary NTP Server | Manual input | The primary NTP server that provide time and date |
| Secondary NTP Server | Manual input | The secondary NTP server that provide time and date |
| Update Interval(secs) | Manual input | The interval that the phone gains time and date from NTP server |
| Daylight | Click drop-down box to select | A switch to control the status that whether to enable the daylight or not |
| Fixed Type | Radio content | Daylight fixed type, only the specified items are configurable |
| Start Month | Click drop-down box to select | The month that the daylight rule begins taking effect |
| Start Date | Manual input | The day that the daylight rule begins taking effect |
| Start Hour of Day | Manual input | The hour of day that the daylight rule begins taking effect |
| Start Day of Week | Click drop-down box to select | The day of week that the daylight rule begins taking effect |
| Start Week of Month | Click drop-down box to select | The week of month that the daylight rule begins taking effect |
| Stop Month | Click drop-down box to select | The month that the daylight rule stops taking effect |
| Stop Date | Manual input | The day that the daylight rule stops taking effect |
| Stop Hour of Day | Manual input | The hour of day that the daylight rule stops taking effect |
| Stop Day of Week | Click drop-down box to select | The day of week that the daylight rule stops taking effect |
| Stop Week of Month | Click drop-down box to select | The week of month that the daylight rule stops taking effect |

| | | |
|------------------------|--------------|-------------------------------------------------|
| Offset(minutes) | Manual input | The offset time that daylight rule takes effect |
|------------------------|--------------|-------------------------------------------------|

Manual Settings



Path to set on the phone: **Press** → **Settings** → **Basic Settings** → **Time & Date** → **Manual Settings**.

Please move the navigation key to check more:



| Item | Operation | Description |
|---------------|-------------------------------------------------|-------------|
| Year | Key in "Year" with the number key, "*"and "#" | Date info |
| Month | Key in "Month" with the number key, "*"and "#" | |
| Day | Key in "Day" with the number key, "*"and "#" | |
| Hour | Key in "Hour" with the number key, "*"and "#" | Time info |
| Minute | Key in "Minute" with the number key, "*"and "#" | |
| Second | Key in "Second" with the number key, "*"and "#" | |

Set the Time & Date manually via web: **Phone**→**Preference**.

Manual Time

Date

Time

| Item | Operation | Description |
|--------------------|----------------------------------------------------------------------|-------------------------------------------------------------------------|
| Manual Time | Click the drop-down box to select | A switch to control the status whether to enable the manual time or not |
| Date | Manual input, click "Generated Date" to gains date from the computer | Set date manually |
| Time | Manual input, click "Generated Time" to gains time from the computer | Set time manually |

3. Time&Date Format



Path to set on the phone: **Press** → **Settings** → **Basic Settings** → **Time & Date Format**.

please move the navigation key to check more:

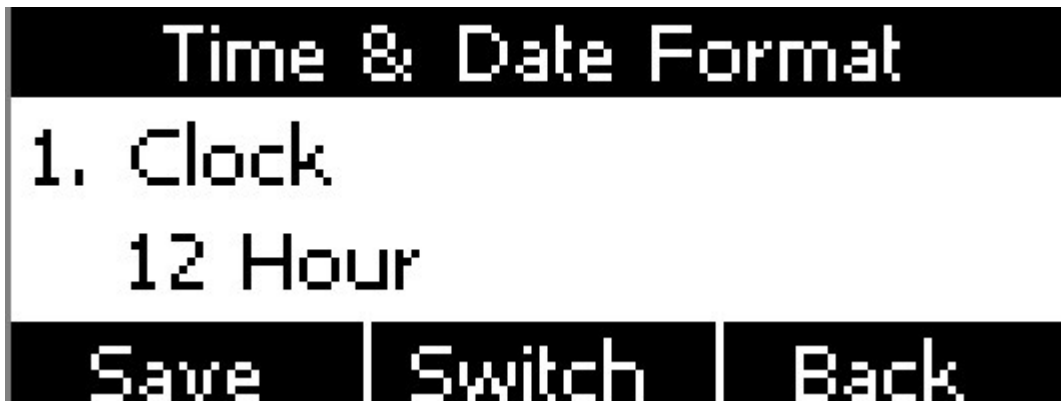

| Item | Optional | Example of result |
|--------------|----------|-------------------|
| Clock | 12 hour | 03:30pm |

| | | |
|-------------|-------------|-----------------|
| | 24 hour | 15:30 |
| Date | WWW MMM DD | TuesdayOct.16 |
| | DD-MMM-YY | 16-Oct.-16 |
| | YYYY-MM-DD | 2016-10-16 |
| | DD/MM/YYYY | 16/10/2016 |
| | MM/DD/YY | 10/16/16 |
| | DD MMM YYYY | 16,Oct.,2016 |
| | WWW DD MMM | Tuesday,17,Oct. |

Set the Time &Date Format via Web: **Phone**→**Preference**



4. Ringtones

10 different ringtones have been provided by D2SV for selection. Path to set on the phone:



Press the key →**Settings**→**Basic Settings**→**Ringtones**.



For the selected ringtone, there is a dot inside the circle. Press the key   to select other ringtone for playing.

Set ringtones via Web: **Account**→**Basic**→**Ring tones**.

5. Headset Memory Mode

Headset memory mode can be used to control the default device to make or answer calls. This function is disabled by default, which means the phone will communicate with others by hand-free when pre-dial or making calls from history or contacts, and so is the situation that pressing "Answer" soft key to accept an incoming call. Once this function is enabled, the phone will make or answer calls by headset. Long press  can change the status of the "Headset Memory Mode".



This function can be configured on the phone only: **Press**  **→Settings→Basic Settings→Headset Memory Mode.**

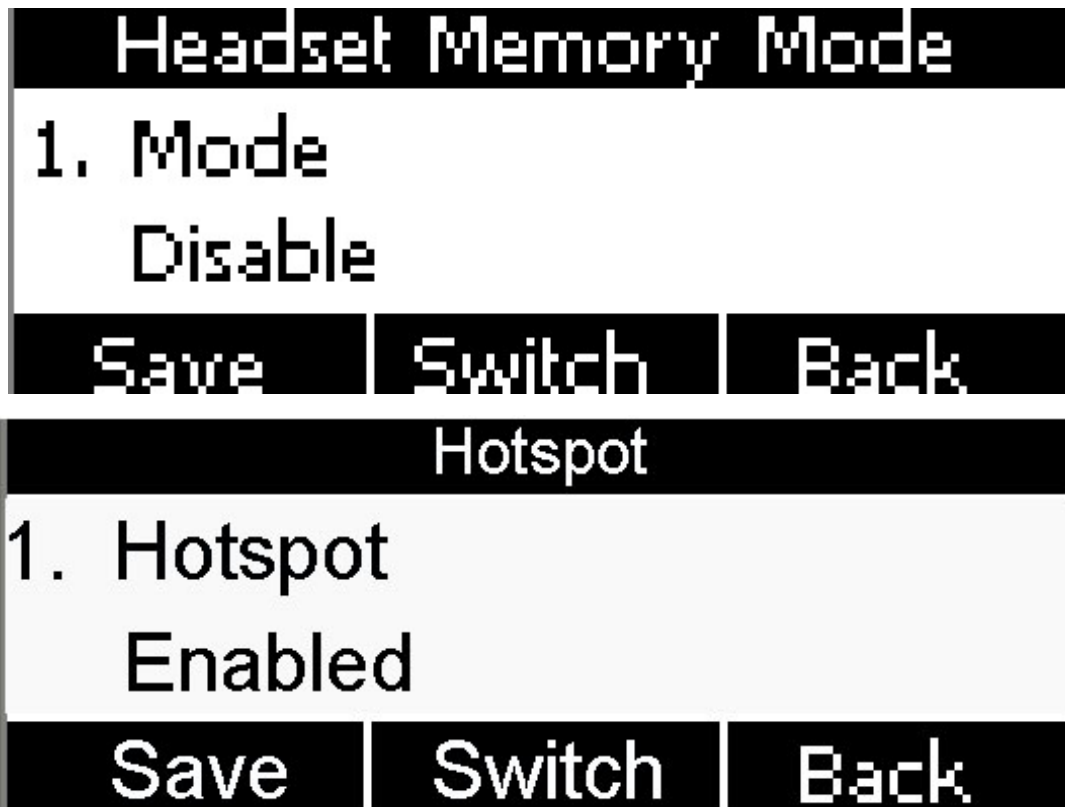

6. Phone Unlock PIN

Phone Unlock PIN: Unlock the phone locked conditions.

please move the navigation key to check more and press the cancel key to back the function,

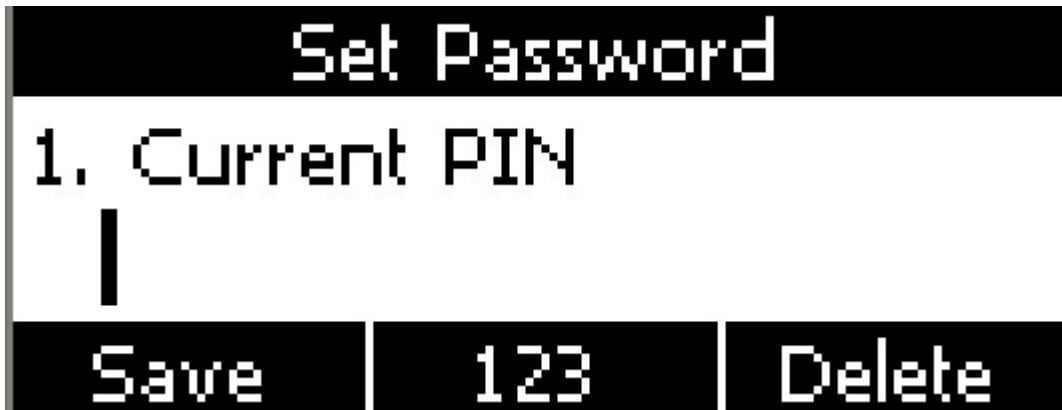

| Item | Operation | Description |
|--------------------|--------------|-----------------------------|
| Current PIN | Manual input | Input the phone current PIN |
| New PIN | Manual input | Set the new PIN |
| Confirm PIN | Manual input | Confirm the new PIN |

Advanced Settings

Password will be requested while accessing the page of "Advanced Settings". This password is the same as the user's ("admin") to access.

1. Account

path to set the account info on phone: Press  → **Settings** → **Advanced Settings** → **Input password** → **Accounts**.

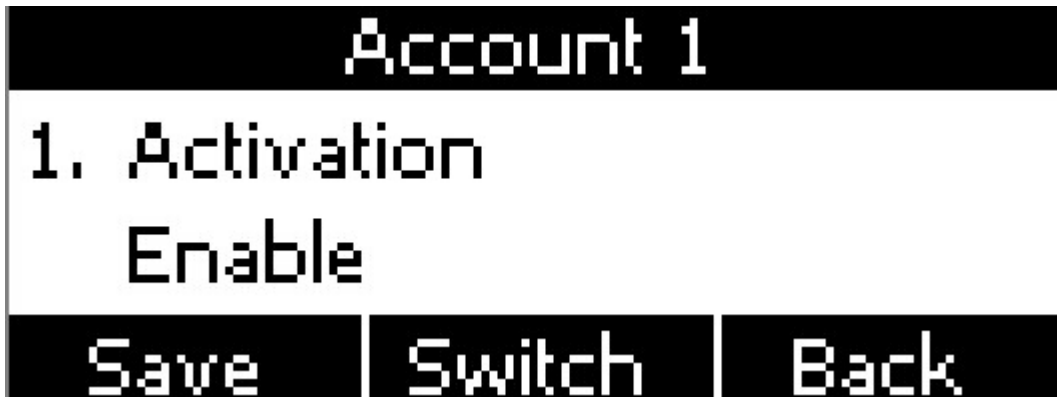

| Item | Description |
|------------------------|----------------------------------------------------------------------------------------------------------|
| Activation | The status of account, the default is "Enable", if set this as "Disable", the account will be forbidden. |
| Label | It will show on the phone, can skip this item |
| Display Name | Parameter that in the SIP, if the SIP Server is supportable, this name will show on the phone of called |
| Register Name | The register ID, supplied by SIP Server, can skip this item |
| User Name | Account ID |
| Password | Password for account |
| SIP Server | The address that accounts needed to register from |
| Outbound Status | The status of Outbound Server, "off" by default |
| Outbound Proxy | IP address of Outbound Agency |
| Stun Status | The status of Stun Server, "off" by default |
| Stun Server | IP address of Stun Server |

Configure account via web: **Account**→**Basic**

| atcom | | Basic | Account | Network | DSS Key | Phone | Contacts |
|--------------|------------------------------|------------------------|-------------|---------|---------|-------|----------|
| Basic | Account | | Account 1 ▼ | | | | |
| Codecs | Register Status | Register failed | | | | | |
| Advanced | Account Active | Enable ▼ | | | | | |
| | Label | <input type="text"/> ⓘ | | | | | |
| | Display Name | <input type="text"/> ⓘ | | | | | |
| | Register Name | <input type="text"/> ⓘ | | | | | |
| | * User Name | <input type="text"/> ⓘ | | | | | |
| | Password | <input type="text"/> ⓘ | | | | | |
| | * SIP Server | <input type="text"/> | Port | 5060 | ⓘ | | |
| | Enable Outbound Proxy Server | Disable ▼ ⓘ | | | | | |
| | Outbound Proxy Server | <input type="text"/> | Port | 5060 | ⓘ | | |
| | Transport | UDP ▼ ⓘ | | | | | |
| | NAT Traversal | Disable ▼ ⓘ | | | | | |
| | STUN Server | <input type="text"/> | Port | 3478 | ⓘ | | |

2. Set Password

The password for Advanced Settings also is used for Web access as the role "admin". Path to

set password on phone: Press  → **Settings** → **Advanced Settings** → **Input password** → **Set Password**.



| Item | Description |
|------|-------------|
|------|-------------|

| | |
|--------------------|--------------------------------------------------------------------------------------|
| Current PWD | The current password for web access as the role of "admin", it's "admin" by default. |
| New PWD | To set the new password, blank is acceptable. |
| Confirm PWD | Input the new password again, to confirm the new password. |

Set password via Web: **Phone**→**Security**.

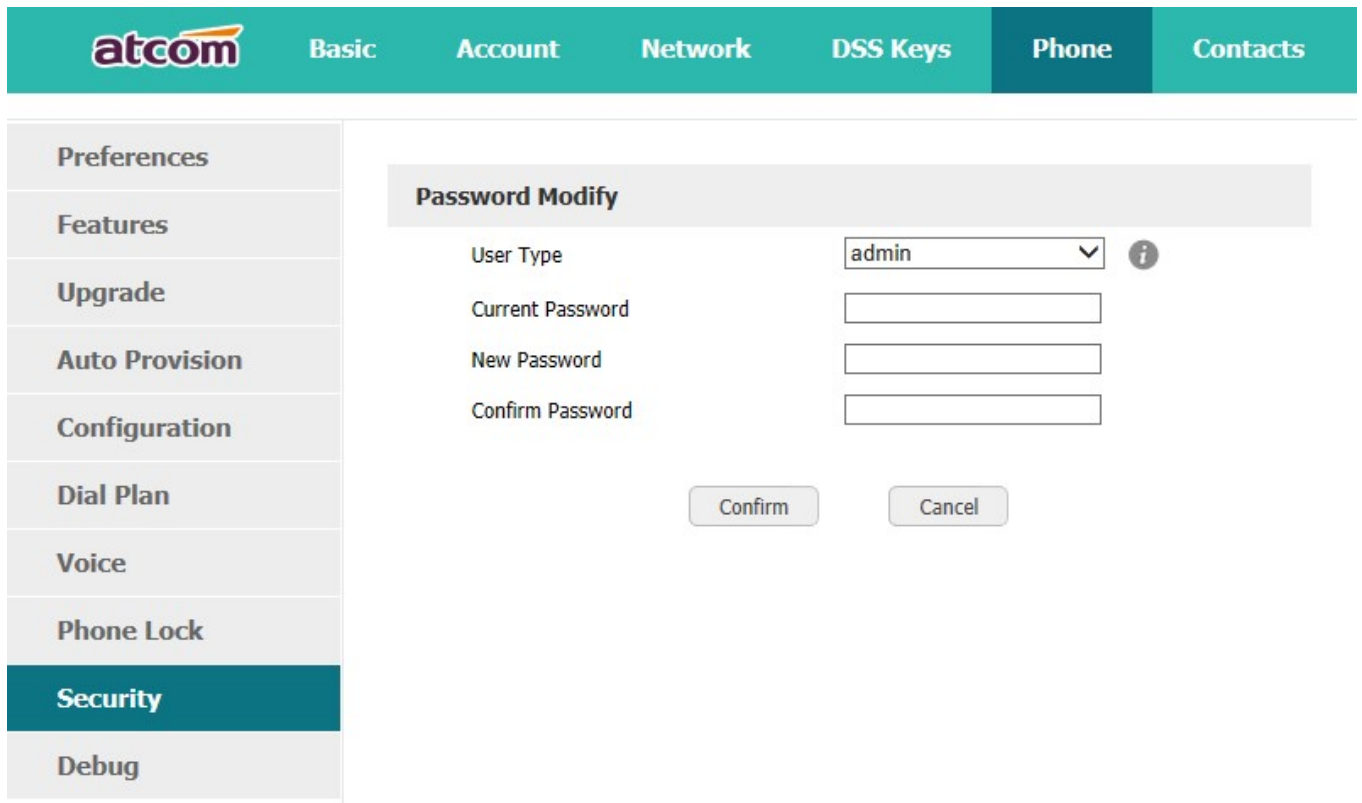

The screenshot shows the atcom web interface with the 'Phone' tab selected. The left sidebar contains a menu with 'Security' highlighted. The main content area displays the 'Password Modify' form, which includes a 'User Type' dropdown menu set to 'admin', and three input fields for 'Current Password', 'New Password', and 'Confirm Password'. Below the input fields are 'Confirm' and 'Cancel' buttons.

3. Network

Path to set network parameters on phone: **Press**  → **Settings**→**Advanced Settings**→**Input the password**→**Network**.

please move the navigation key to check more:



➤ APN Settings

APN (Access Point Name), is a parameter that must be configured when the phone obtains the network, which determines the method of the phone to access the network, and is used to indicate the type of GPRS service.



Path to set APN on phone: **Press**  **→Settings→Advanced Settings→Input the password→Network→APN Settings→Custom APN, enable the APN and input the APN info**

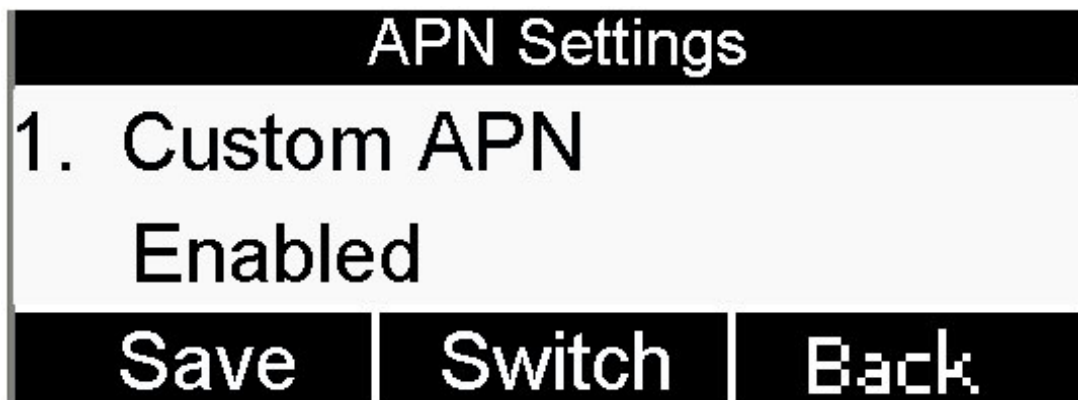

Path to set APN on the webpage:

| Basic | Account | Network | DSS Keys | Phone | Contacts |
|----------|-----------------------------------------------|---------|----------|-------|----------|
| Wi-Fi | APN | | | | |
| APN | Active: <input type="text" value="Enabled"/> | | | | |
| Advanced | Name: <input type="text" value="backspace"/> | | | | |
| Ping | User: <input type="text"/> | | | | |
| | Password: <input type="text"/> | | | | |
| | Auth Type: <input type="text" value="0"/> | | | | |
| | Auth Protocol: <input type="text" value="0"/> | | | | |
| | | | Confirm | | Cancel |

➤ Wi-Fi Hotspot(Wi-Fi AP)

The phone turns on the Wi-Fi hotspot (Wi-Fi AP) function by default, the LCD would appear the icon . the **initial SSID** and **password** of the hotspot can be viewed on the sticker on the phone back cover.

Please press **Menu**→ **Wi-Fi Settings**→ **Hotspot**, you can choose to turn on or off the hotspot, and press the down navigation key to view or modify the initial name and password.

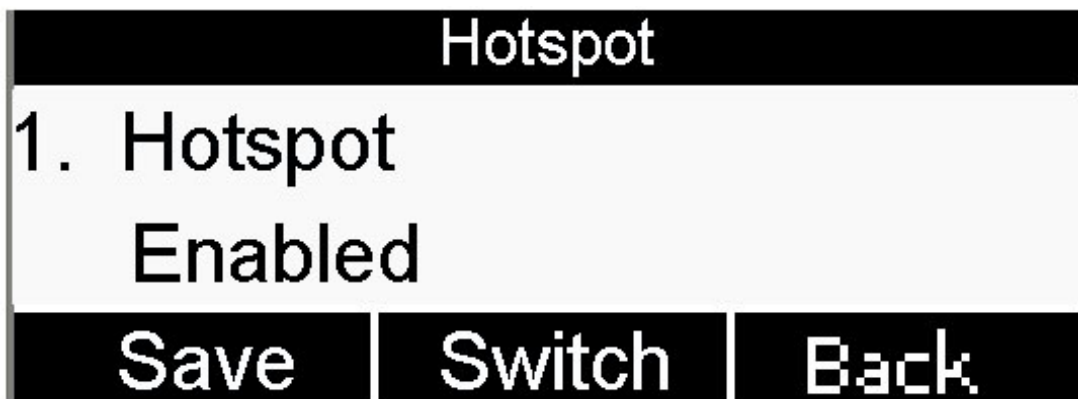

➤ Network selection

The phone network type supports 4G/3G/2G by default, and can be selected as 4G, 4G/3G, 3G, 3G/2G, 2G and other modes.

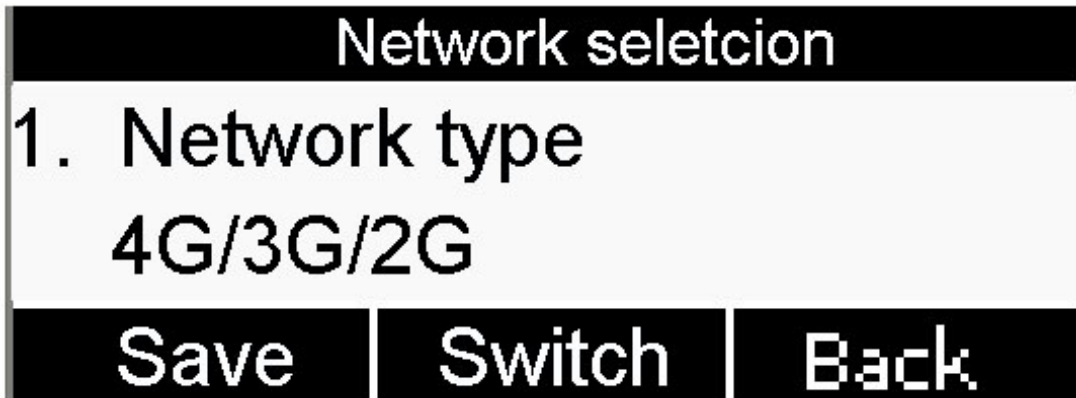

The phone can choose three call modes such as VoLTE/SIP, VoLTE, SIP (need to support VoLTE call phone)

4. Keypad Lock

It support enable or disable the keypad lock feature, if enable, **the default password is 123:**

Please move the navigation key to check more

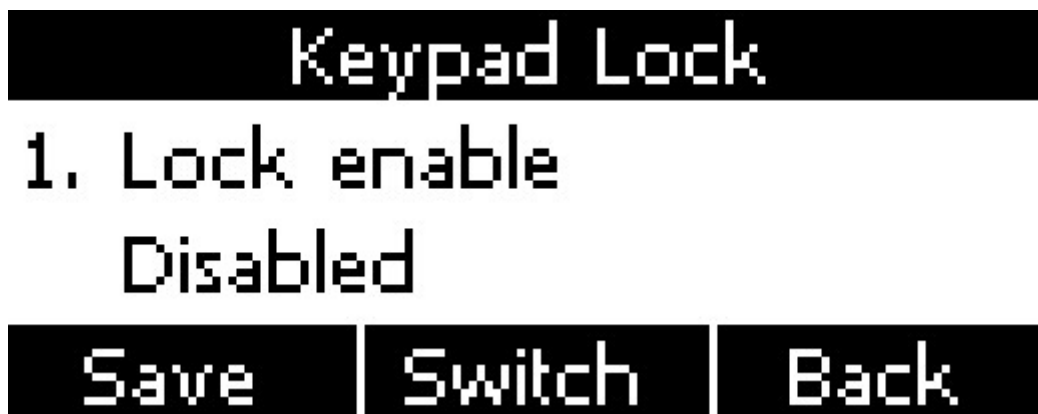

Keypad lock via webpage: **phone**→**Phone lock**

| atcom | | Basic | Account | Network | DSS Keys | Phone | Contacts |
|-------------------|--|-------|---------|---------|----------|-------|----------|
| Preferences | | | | | | | |
| Features | | | | | | | |
| Upgrade | | | | | | | |
| Auto Provision | | | | | | | |
| Configuration | | | | | | | |
| Dial Plan | | | | | | | |
| Voice | | | | | | | |
| Phone Lock | | | | | | | |
| Security | | | | | | | |
| Debug | | | | | | | |

Phone Lock

| | |
|------------------------------|-----------------------------------------------------------------------------------------------------|
| Keypad Lock Enable | <input type="text" value="Disable"/> |
| Keypad Lock Type | <input type="text" value="Menu Key"/> |
| Phone Unlock PIN(0~15 Digit) | <input type="text" value="..."/> |
| Phone Lock Time Out(0~3600s) | <input type="text" value="10"/> |
| Emergency | <input type="text" value="110,120,119,911"/> i |

1. Keypad Lock Enable: select "Yes" or "No" to enable or disable keypad lock
2. Keypad Lock Type: Menu key/Function keys/All keys/Answer call only.
3. Phone Unlock PIN(0~15 Digit):set the phone unlock PIN. Range: 0~15 digit.
4. Phone Lock Time Out(0~3600s): set the phone lock time out. Range: 0~3600s
5. Emergency :set emergency number. Default to 110.120.119 and 911.

5. Reboot

After the restart, the phone will back to standby interface.

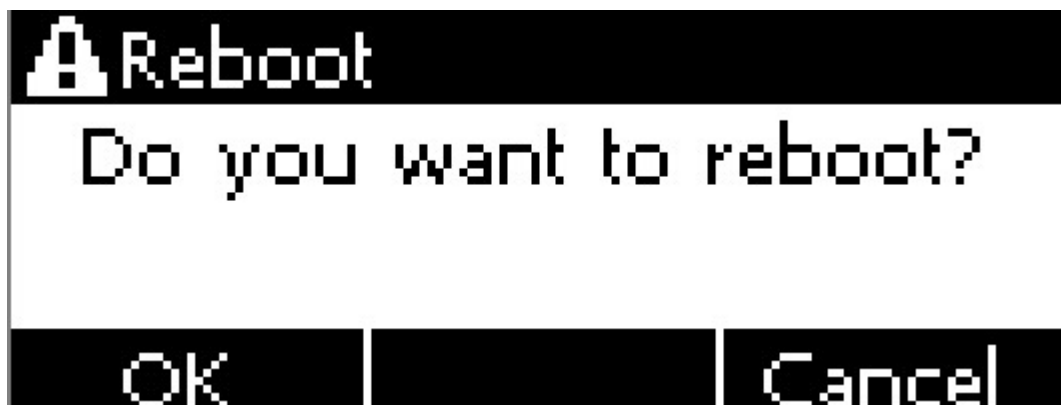

Reboot via webpage: **Phone**→**Upgrade**→**Reboot**

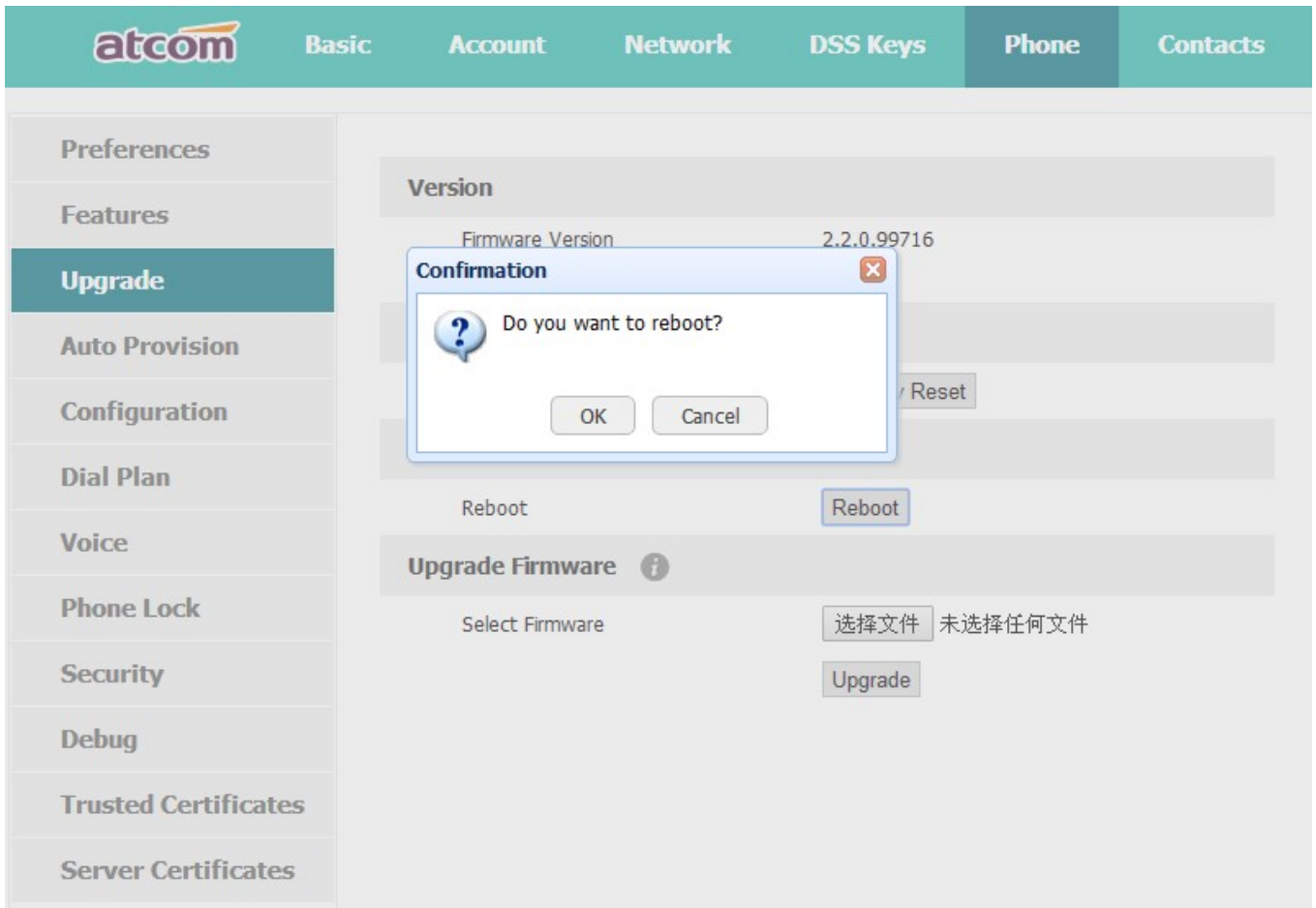

4. SIM card lock setting

5. Reset to factory

Once reset to factory, all parameter settings will back to the factory default value, and all configure will be cleared, users must be careful on this.

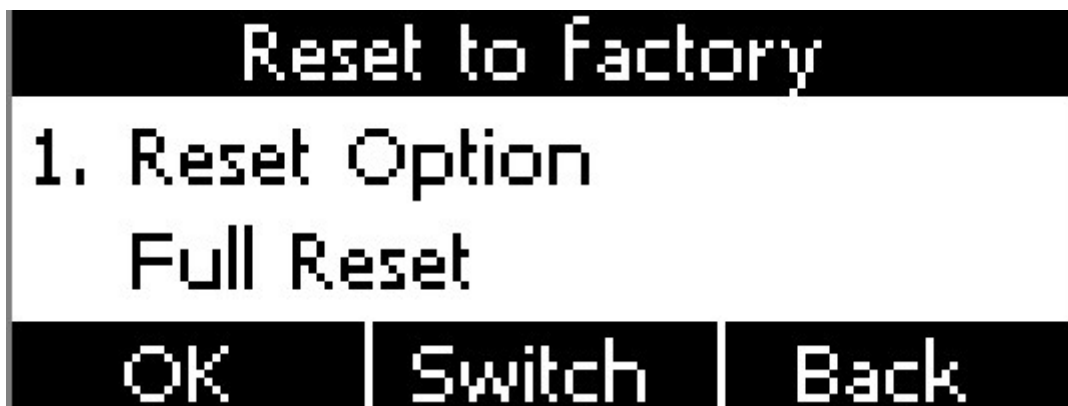

Reset Option: **Full Reset**, **Config Reset** and **UserData Reset**.

Reset to factory via Web: **Phone**→**Upgrade**→**Reset to Factory**.

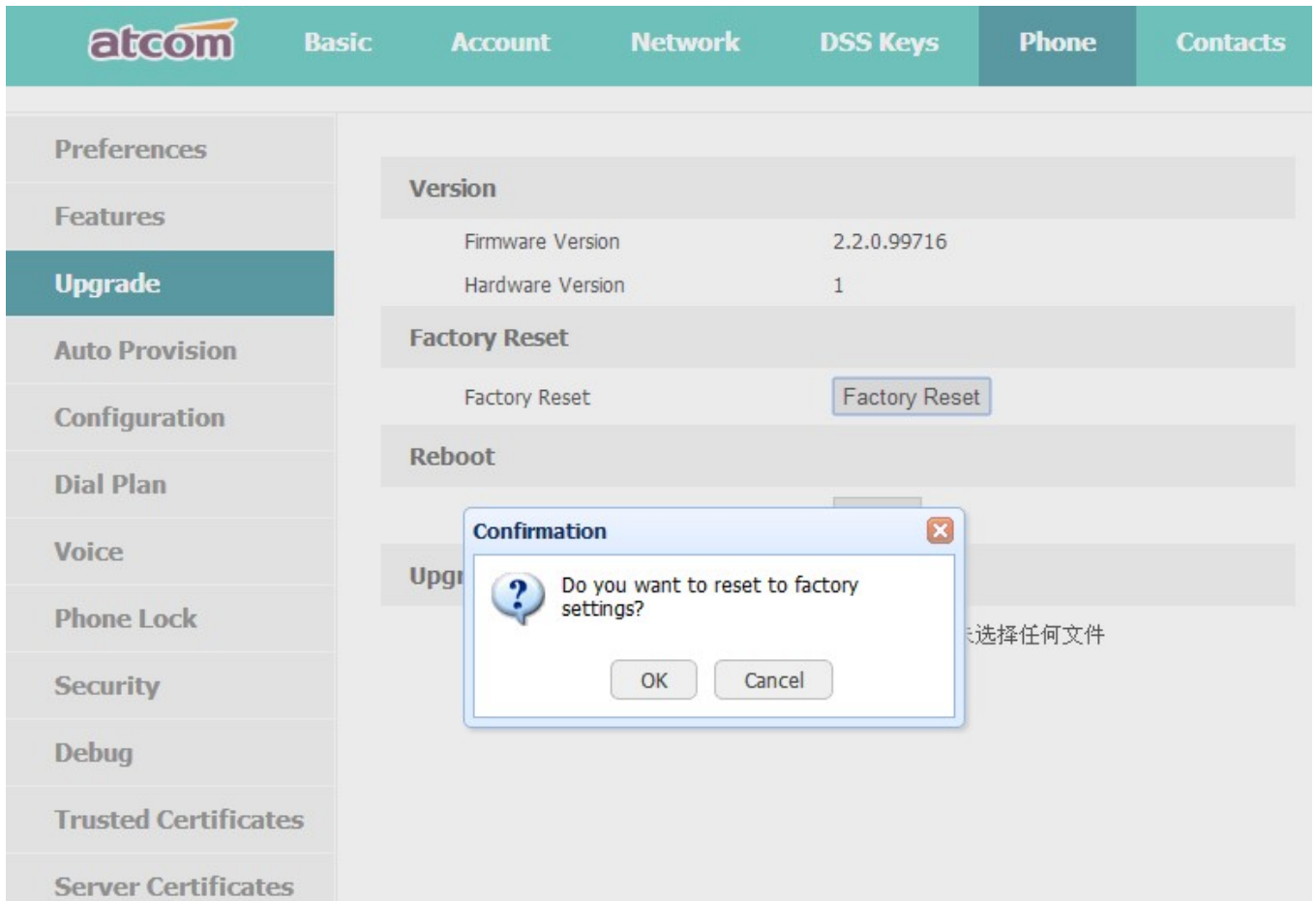



3.4.7. Display

For more convenient, users are able to adjust the contrast grade and backlight of the main LCD display.



1. Slave Contrast

There are 9 different contrast grades for options, press the soft key "Switch" or the key .

 for modification, 8 is the default value.

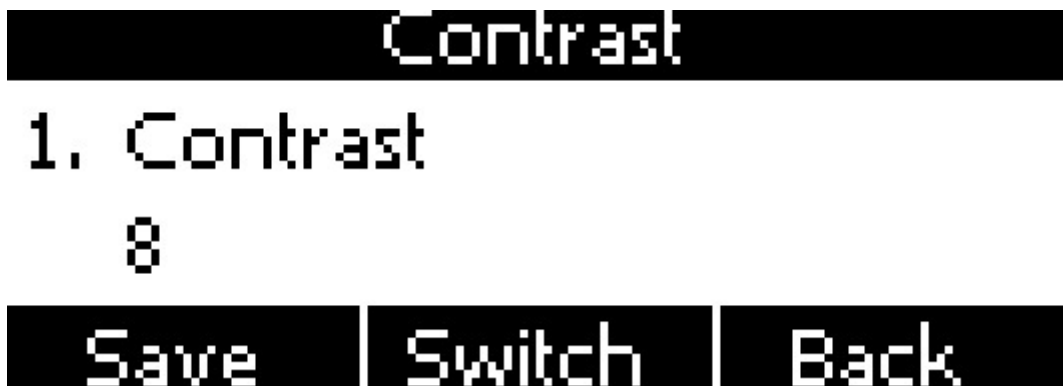

2. Backlight

Backlight is the brightness of LCD, also it has been defined as 9 different grades. The number "9" means the lightest.

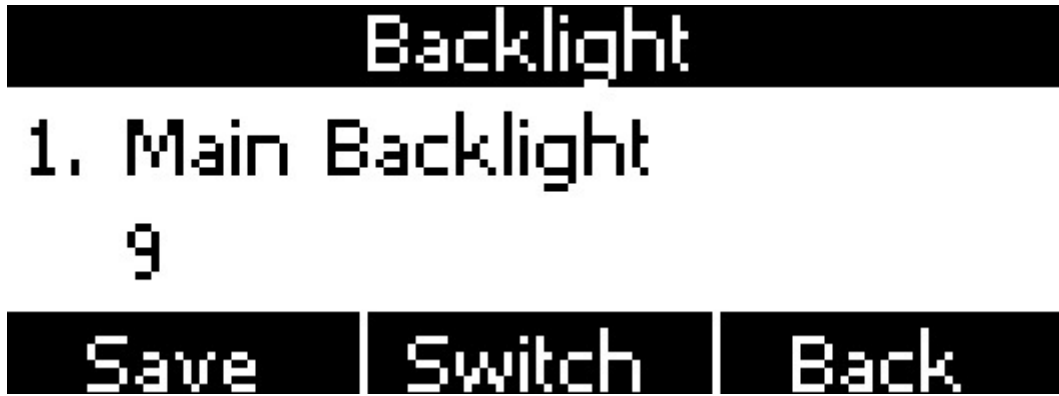



4. Advanced Feature

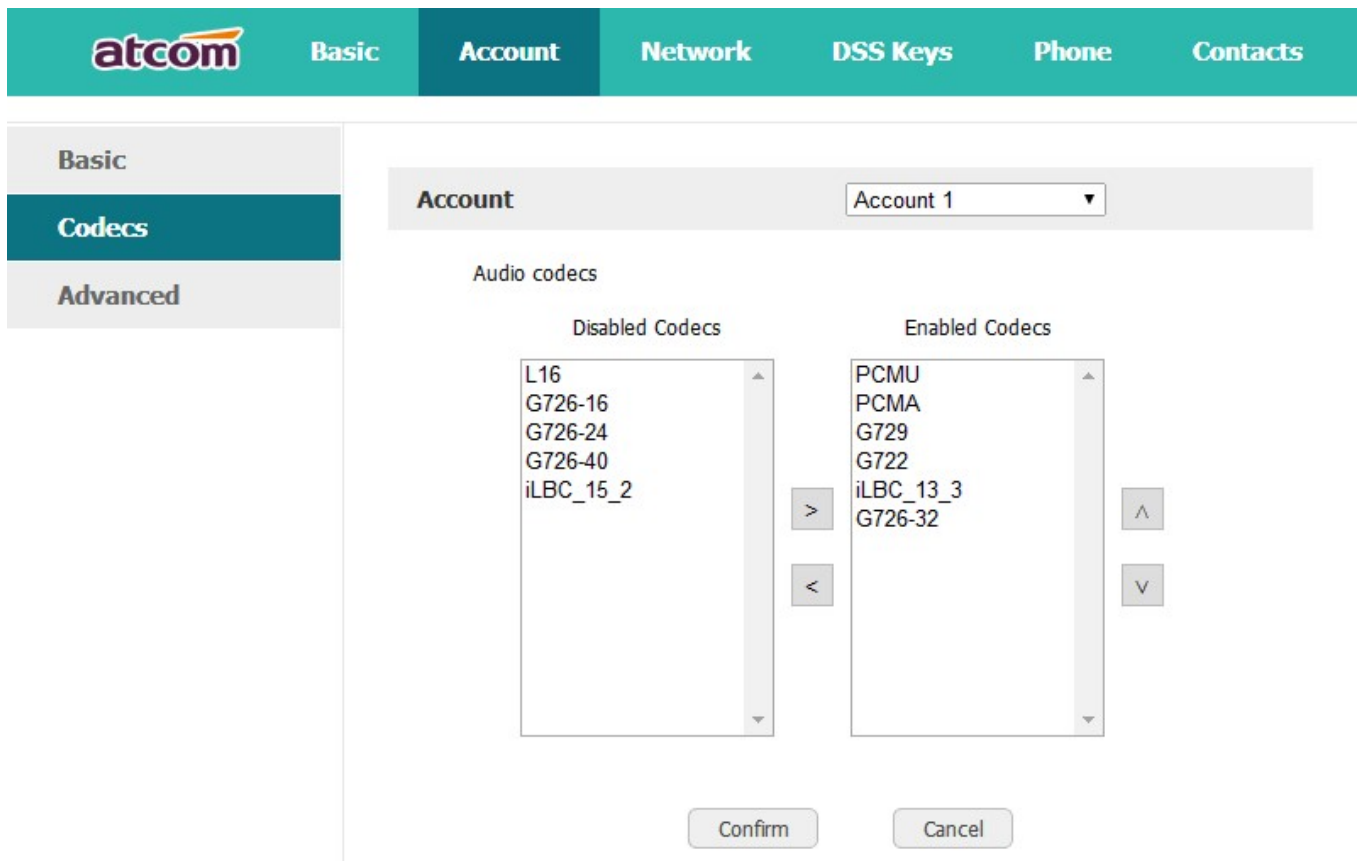

4.1. Codecs

D2SV support multiple codecs, users can select the codes via Web.



 means to enable the item of “Disabled Codes” ;

 means to disable the item of “Enabled Codes” ;

Click the button  or  to sort all enabled codes, the top item has the highest priority.

Note: Multiple different items of G726, iLBC should not activated simultaneously.

4.2. Capture and Upgrading

Capture package:

It would record the phone current info.

Via webpage: **phone**→**Debug**→**PCAP Feature**

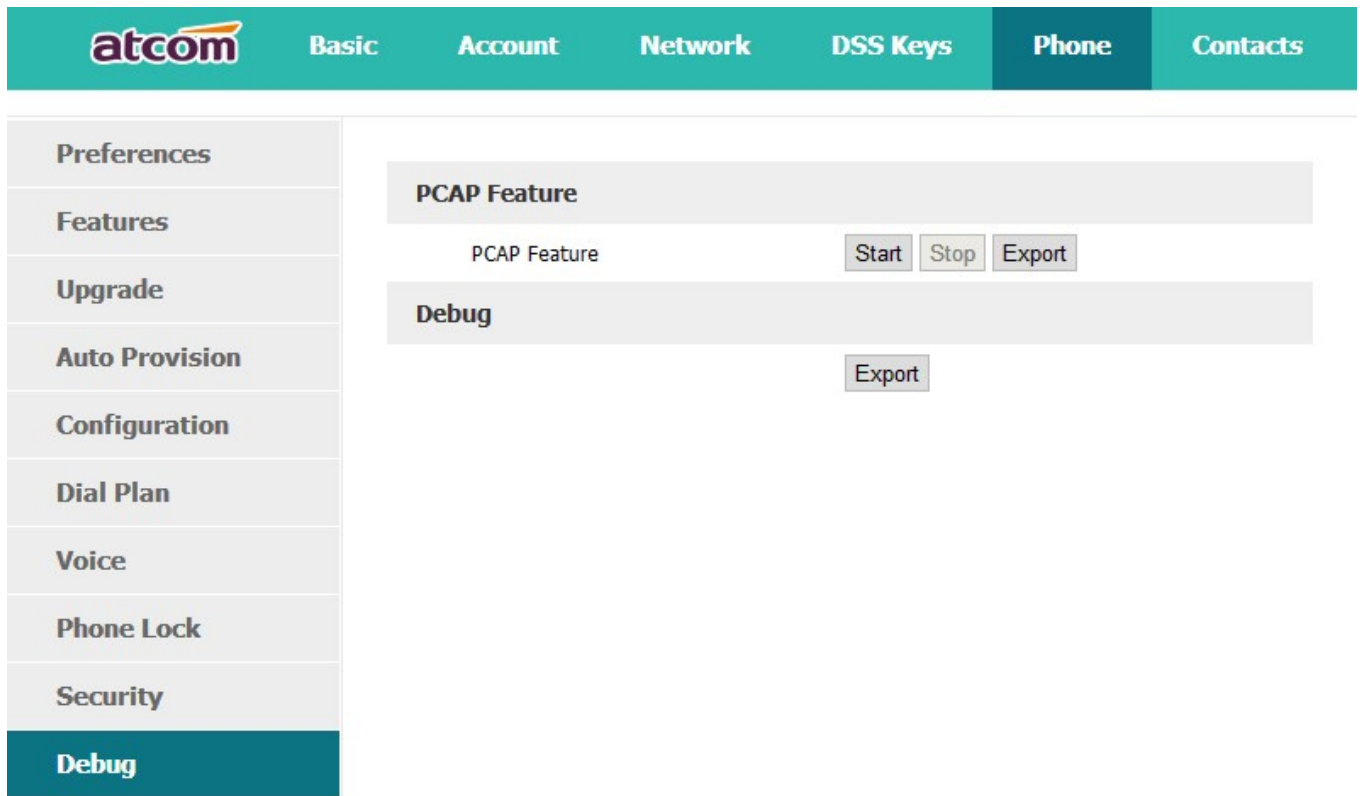

The screenshot shows the atcom web interface with the 'Phone' menu item selected. The left sidebar contains a list of menu items: Preferences, Features, Upgrade, Auto Provision, Configuration, Dial Plan, Voice, Phone Lock, Security, and Debug (which is highlighted). The main content area displays the 'PCAP Feature' section with a 'Start' button, a 'Stop' button, and an 'Export' button. Below this is the 'Debug' section with an 'Export' button.

Click the button "Start" to start the capture and click the button "Stop" to end the capture. Then click the button "export" to download the capture file.

Upgrade firmware:

Via webpage: **phone** → **Upgrade** → **Upgrade Firmware**

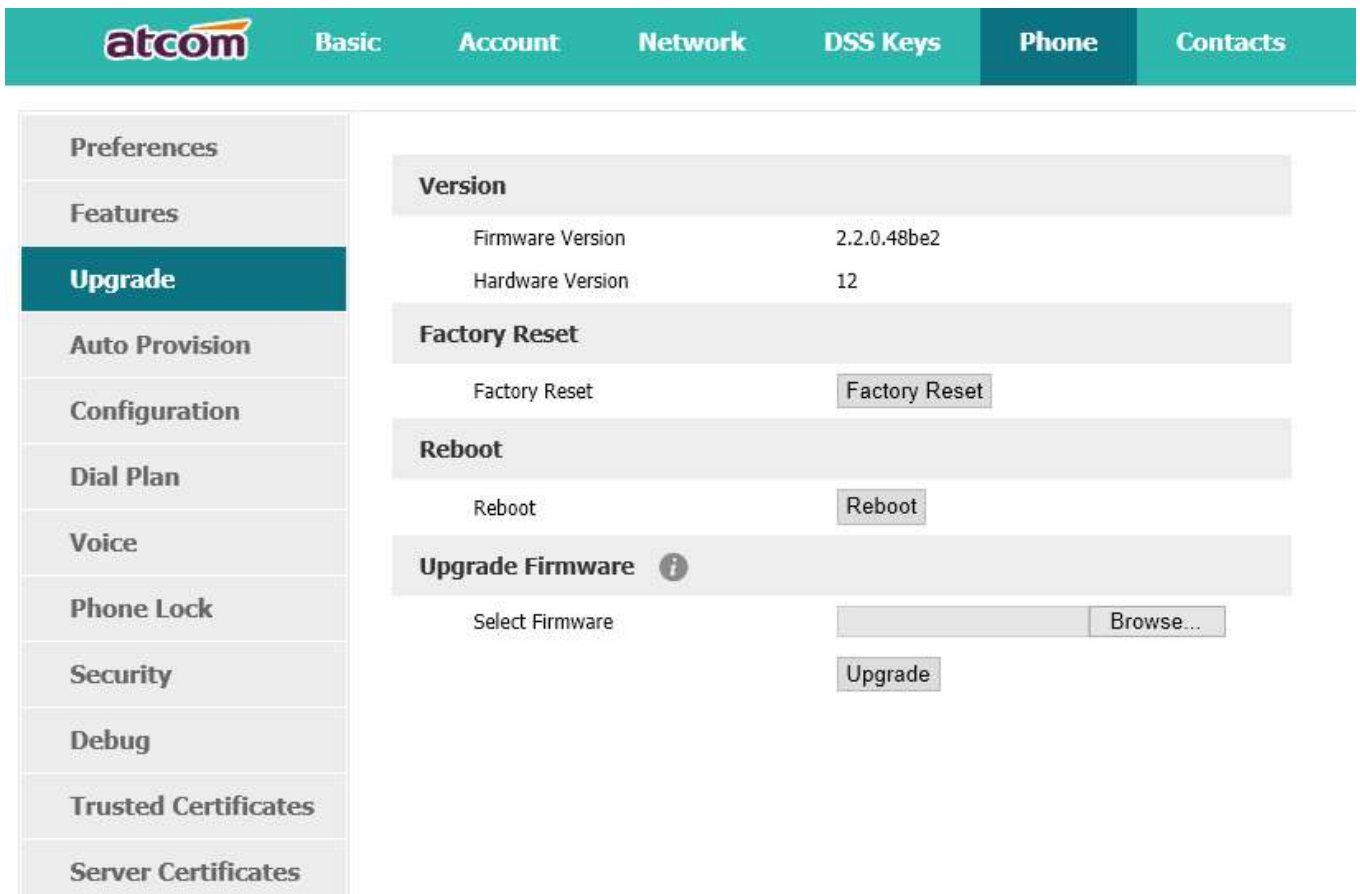

The screenshot shows the ATCOM web interface with the 'Phone' tab selected. The left sidebar contains a menu with 'Upgrade' highlighted. The main content area displays the 'Upgrade Firmware' section, which includes a 'Version' table, 'Factory Reset' and 'Reboot' buttons, and a 'Select Firmware' field with a 'Browse...' button and an 'Upgrade' button.

| Version | |
|------------------|-------------|
| Firmware Version | 2.2.0.48be2 |
| Hardware Version | 12 |

Factory Reset

Factory Reset

Reboot

Reboot

Upgrade Firmware ⓘ

Select Firmware

Before upgrading the firmware of phone, users are suggested to check the version of current firmware. Click the button "Choose file" to select the target local file and click "Upgrade" to process upgrading, this will cost a couple of minutes. And after reboot, the phone will be upgraded successfully.

4.3. Auto Provision

User is able to configure the phone to upgrade automatically.

atcom Basic Account Network DSS Keys **Phone** Contacts

- Preferences
- Features
- Upgrade
- Auto Provision**
- Configuration
- Dial Plan
- Voice
- Phone Lock
- Security
- Debug

Auto Provision

PnP Active On Off i

DHCP Active On Off i

Provisioning Server i

User Name

Password i

Common AES Key

MAC-Oriented AES Key

Check New Config On Off i

Repeatedly On Off

Interval(minutes)

Weekly On Off

Time : -- :

Day of week

- Sunday
- Monday
- Tuesday
- Wednesday

| Item | Description |
|-----------------------------|-------------------------------------------------------------------------------------------------------------------------------------------|
| PnP Active | Select "On" or "Off" to enable or disable PNP automatic updates |
| DHCP Active | Select "On" or "Off" to enable or disable DHCP option automatic updates |
| Provisioning Server | The address to save control file for auto upgrading, it can filled by http, https, tftp and ftp server, for example, tftp://192.168.1.111 |
| User Name | The username to access the file server |
| Password | The password to access the file server |
| Common AES Key | Configures the plaintext AES key for decrypting the Common CFG file |
| MAC-oriented AES KEY | Configures the plaintext AES key for decrypting the MAC-oriented CFG file |

| | |
|--------------------------|--------------------------------------------------------------------------------------------------------------------------------------------------------------------|
| Check New Config | If set this parameter as "On", the phone will do some check for upgrading, and it will upgrade automatically once the conditions are met |
| Repeatedly | If set this parameter as "On", the phone will do some check for upgrading after "Interval(minutes)", and it will upgrade automatically once the conditions are met |
| Interval(minutes) | This parameter is configurable once the Repeatedly is "On" |
| Weekly | If set this parameter as "On", the phone will do the check for upgrading at a certain time in every week |
| Time | The time range that the phone do the check for upgrading every week, and it's configurable once the Repeatedly is "On" |
| Day of week | The day of week that the phone do the check for upgrading every week, and it's configurable once the Repeatedly is "On" |

4.4. Export & Import configuration file

If user wants to set the same configuration on multiple phones, there is an easy way that export the configuration file from one phone and then import this file into other phones. This operation can be completed via Web only.

Import / Export Config

Import File 

Choose file No file chosen

Import Export Export User Data

4.4.1. Export configuration file

There is two ways to export the configuration files,

- Don't check the "Export User Data" and click "Export" directly, it will export the template of the configuration file;
- Check the "Export User Data" and then click "Export", it will export a configuration file that carries with user's configured data.

To modify the exported configuration file, you should to decompress it until you get a file names as configuration.

| Name | Date modified | Size |
|---------------|------------------|------|
| configuration | 2014/10/10 11:14 | |
| config.tar.gz | 2014/10/10 11:14 | 9 KB |

The content of configuration file listed as below,

| Name | Date modified | Type | Size |
|----------|------------------|-------------|------|
| Calllist | 2014/10/10 11:14 | File folder | |
| Contacts | 2014/10/10 11:14 | File folder | |
| DialRule | 2014/10/10 11:14 | File folder | |
| Features | 2014/10/10 11:14 | File folder | |
| Network | 2014/10/10 11:14 | File folder | |
| Phone | 2014/10/10 11:14 | File folder | |
| Setting | 2014/10/10 11:14 | File folder | |
| voip | 2014/10/10 11:14 | File folder | |

4.4.2. Import configuration file

Click the button "Choose file" to select the target file for importing, and then click the button "Import". The phone will be rebooted a couple of minutes later, and import successfully.

Note: If some part of the configuration file has been modified manually, it must be re-compressed as the format of "tar.gz" in Linux

4.5. Export System log

When the phone doesn't working well, System log is the best assistant tools for troubleshooting, all operation details has been recorded. This operation is available via Web only.

Export System Log

Log Location Local Server i

Server Name

Log Level

| Item | Description |
|---------------------|------------------------------------------------------------------------------------------------------------------------------------------|
| Log Location | You can import the system log to local PC or remote Server. |
| Server Name | User must fill the address of server if you choose to export the system log to remote server. |
| Log Level | It defines the detail of system log as 5 different levels, Fatal, Error, Warning, Info, and Debug. The Debug level is the most detailed. |

4.6. Dial plan

The customized Dial Plan are available , for example , the rule of replacement, Instant Calling, Area code, Restriction of Outbound.

Before customizing the dial plan, user must learn the basic grammar as below,

| | |
|----|---------------------------------------------------------------------------------------------------------------------------------------------------------------------------------------------|
| . | Represent a character or multiple ones, e.g., "6." can match "66","678","6plus" and so on |
| x | Represent one character, e.g., "6x" can match "61","62", " 6s" and so on |
| [] | Represent a character in one range, e.g., " 83[0-5]18618"can match"83018618","83488618" and so on |
| () | Represent the combination of characters, e.g., "([1-9])([2-7])3" can match "923","153","773" and so on |
| \$ | Add a number after the character "\$" to define the location of the characters, e.g., use the prefix " 8([1-3])(.)" to replace "7\$2", the phone will call "7837" after dialing out "82837" |

Note: Any operations (add, modify or delete) on the current dial plan will be not effective until click "Save".

4.6.1. Replace Rule

Dial plan "Replace Rule" means to replace a batch of complicated character string by some simple characters, to make a speed dial.

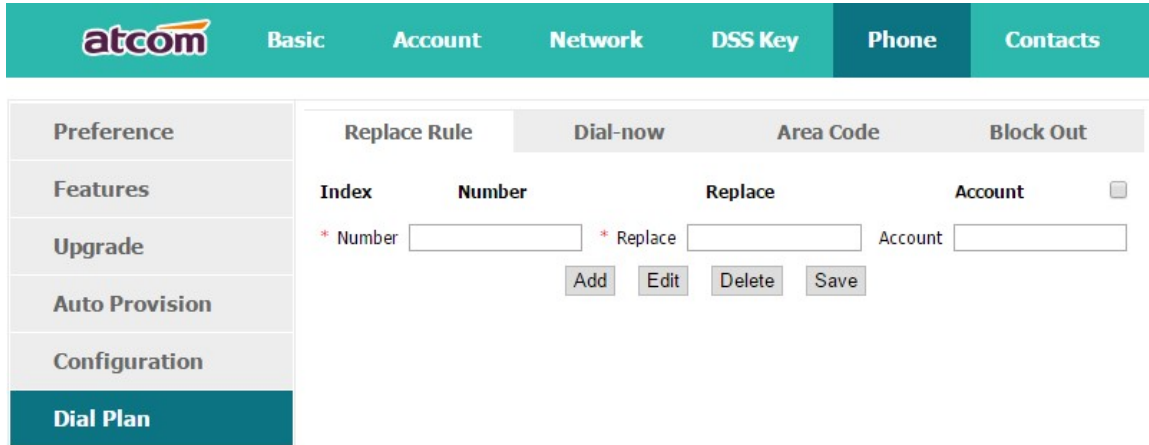

| Item | Description | Sample |
|----------------|---------------------------------------------------------------------------------------------------------------------------------------------------------------------------------------------------------------------------------------------------------------|-----------------------------------------------------------------------------------------------------------------------|
| Number | The string works as replacer, not null | Set Number as "6", Set Replace as"6032", Set Account as "1". It means when dial 6, the phone will dial 6032. |
| Replace | The string that to be replaced, not null | |
| Account | The account to apply this dial plan, blank or 1 is valid. | |
| Add | Multiply replace rules can be configured in one phone, after one replace dial plan configured, click this button to add a new one | |
| Edit | The existed replace dial plans are editable. The specified dial plan should be selected until it is covered with orange and the input fields "Number" and "Replace" shows the details correctly. After modifying, click button "Edit" to make it to be effect | |
| Delete | Delete one added or saved replace dial plan or multiple ones, click the frame after the specified replace dial plan before delete it, and then click button "Delete" | |

| | | |
|-------------|----------------------------------------------------------------------|--|
| Save | Any alteration won't take effect until the button "Save" is clicked. | |
|-------------|----------------------------------------------------------------------|--|

4.6.2. Dial-now

Dial plan "Dial-now" permits the corresponding phone to be dialed instantly without pressing the soft key "Dial", once the input has been matched. It works like a hotline.

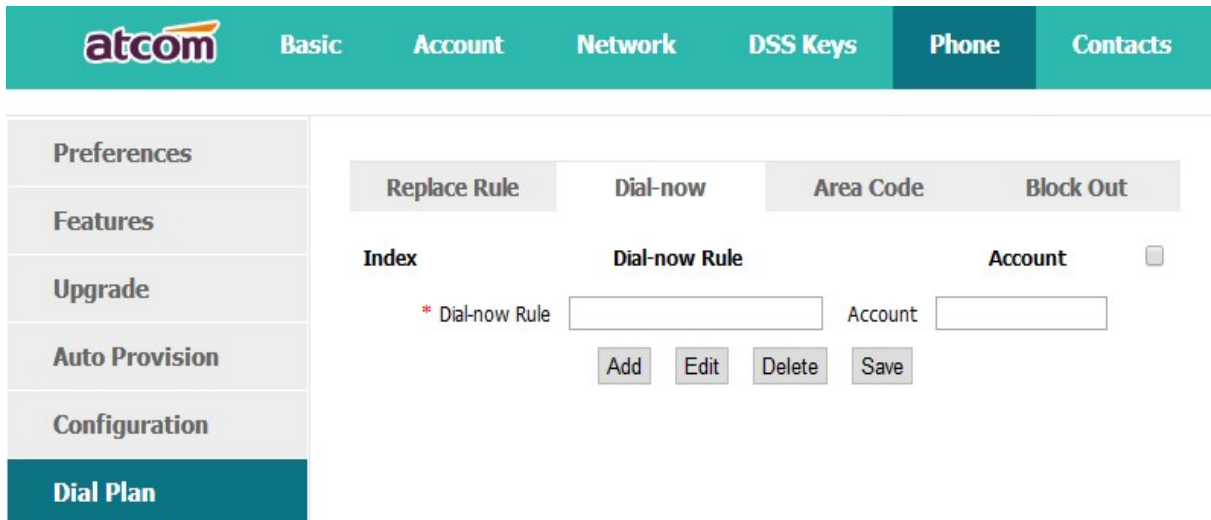

| Item | Description | Sample |
|----------------------|-----------------------------------------------------------------------------------------------------------------------------------------------------------------------------------------------------------------------------------------------------------------|-----------------------------------------------------------------------------------------------------------------------------------------------|
| Dial-now Rule | The string to be dialed out automatically by the phone | Set "Dial-now Rule" as 6xxx, keep "Account" as null |
| Account | The account to apply this dial plan, blank or 1 is valid. | It means the phone will use the 1st available account to call 6033 after "Dial-now Time-out" seconds when inputting four figures begin with 6 |
| Add | Multiply dial-now rules can be configured in one phone, after one dial-now dial plan configured, click this button to add a new one | |
| Edit | The existed dial-now dial plans are editable. The specified dial plan should be selected until it is covered with orange and the input fields "Number" and "Dial-now" shows the details correctly. After modifying, click button "Edit" to make it to be effect | Note: Dial-now rule is different with hotline. The Dial-now rule will take effect when input |

| | | |
|---------------|------------------------------------------------------------------------------------------------------------------------------------------------------------------------|---------------------------------------------------------------------------------------------------------|
| Delete | Delete one added or saved dial-now dial plan or multiple ones, click the frame after the specified dial-now dial plan before delete it, and then click button "Delete" | numbers matches the dial plan, and hotline takes effect in situation that the phone is in dialing state |
| Save | Any alteration won't take effect until the button "Save" is clicked. | |

Set "Dial-now Time-out" via web: **Phone**→**Features**→**General Information**→**Dial-now Time-out (secs)**.

4.6.3. Area Code

Dial plan "Area Code" has been defined to identify each different area. To call a phone number of other areas, user must add the area code to be in front of the phone number. For convenience, area code has been recommended to be configured while frequently dialing to that type of phone number.

| Item | Description | Sample |
|-----------------------|----------------------------------------------------------------------------|---------------------------------------------------------------------------------------------------------|
| Code | The area code dialed before the number | Set "Code" as "0086577", Set "Minimum length" as "5". |
| Minimum length | The minimum length of the number input to activate the area code dial plan | It means when dialing 83018618 with the 5 th account, the phone will dial 0086577 before it. |
| Maximum length | The maximum length of the number input to activate the area code dial plan | |
| Account | The account to apply this dial plan, blank or 1 is valid. | Note: If the length of the |

| | | |
|----------------|-----------------------------------------------------------------|------------------------------------------------------------------------------------------------------------------|
| Confirm | Apply this dial plan | number input in the dial UI is not between minimum length and the maximum length, area code will not take effect |
| Cancel | Recover all input fields to the state that saved at latest time | |

4.6.4. Block Out

Dial plan "Block out" is used to prohibit the phone number outgoing call from some accounts.

| Item | Description | Sample |
|-------------------------|-----------------------------------------------------------------|--------------------------------------------------------------------------------------------------------------|
| Block Out Number | The number that prohibited | Set "Block Out Number 1" as "10086" It means the phone will enter the "Call End" UI when dial "10086" |
| Account | The account to apply this dial plan, blank or 1 | |
| Confirm | Apply this dial plan | |
| Cancel | Recover all input fields to the state that saved at latest time | |

5. WI-FI

5.1. Configure the WIFI on the phone

1. Press “**Menu**”→“**WIFI Settings**”→“**Switch**”, open the WIFI connection mode.
2. Please move the navigation key to check the WIFI you want to connect, Press “**Connect**”, then input the correct WiFi password.
3. Return to the standby interface, and phone successful connected to the wifi.
4. The last option is Manual setting, press ‘Enter’, then input the SSID and password.

5.2. Configure the WIFI on the WEB

A20W and A20WAC connect to network via Wi-Fi acquiescently, click “**Search Wi-Fi**” button to search the available Wi-Fi.

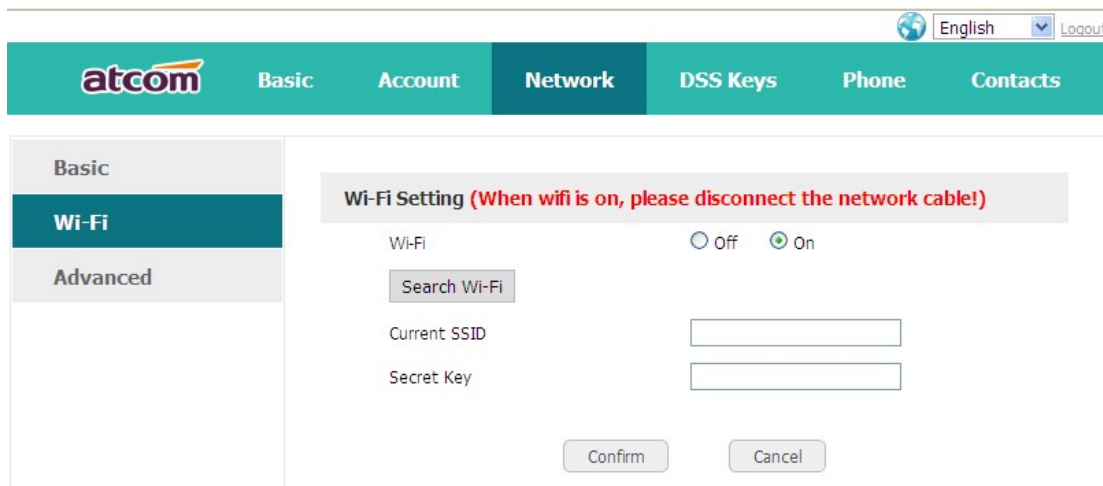



The screenshot shows the ATCOM web interface for configuring Wi-Fi settings. The top navigation bar includes the ATCOM logo and menu items: Basic, Account, Network (selected), DSS Keys, Phone, and Contacts. A language dropdown is set to English, and there is a Logout button. On the left, a sidebar menu has options for Basic, Wi-Fi (selected), and Advanced. The main content area is titled "Wi-Fi Setting (When wifi is on, please disconnect the network cable!)" and contains the following elements:

- Wi-Fi status: Off On
- Search Wi-Fi button
- Current SSID input field
- Secret Key input field
- Confirm and Cancel buttons

After all available Wi-Fi hotspots are listed out, click the round behind the available Wi-Fi which you want to connect.

| Index | SSID | Signal | Select |
|-------|----------------------------|--------|-----------------------|
| 1 | cisco | 211 | <input type="radio"/> |
| 2 | 360 | 207 | <input type="radio"/> |
| 3 | re | 207 | <input type="radio"/> |
| 4 | amoji | 205 | <input type="radio"/> |
| 5 | CHINA TELECOM | 205 | <input type="radio"/> |
| 6 | 360_____WIFI-C9 | 197 | <input type="radio"/> |
| 7 | _____ | 197 | <input type="radio"/> |
| 8 | _____ | 190 | <input type="radio"/> |
| 9 | inWatch3 | 189 | <input type="radio"/> |
| 10 | ChinaNet-7A6t | 188 | <input type="radio"/> |
| 11 | 360_____WIFI-9F | 185 | <input type="radio"/> |
| 12 | iTV-7A6t | 185 | <input type="radio"/> |
| 13 | inWatch2 | 185 | <input type="radio"/> |
| 14 | Royale International China | 184 | <input type="radio"/> |

Input the right "Secret Key" and then click the "Confirm" button, the phone will reboot, after rebooting, the Wi-Fi icon will display on the home screen, it means connect failed when the icon come with , then you should check the configuration. if the icon come with , it means connect successfully.

5.3. Enterprise WiFi

It supports WPA/WPA2 Enterprise wifi , it is based on Radius sever and configuration the Enterprise wifi in the router.

Configure the Enterprise wifi:

1. Upload the Certificates

Via the webpage: "Phone" → "Trusted Certificates"

| Index | Issued To | Issued By | Expiration | Delete |
|-------|-----------|-----------|------------|--------------------------|
| 0 | | | | <input type="checkbox"/> |

Import Trusted Certificates

Load trusted certificates file

2. Input the WIFI account info

Via the webpage: "**Phone**"→"**Network**"→ "**WIFI**"

Press the "Search WIFI", and select the SSID, then input the radius ID and password.

Via the phone:

Press "**Menu**"→"**WIFI Settings**", and select the SSID , then input the radius ID and password.

6. LTE Network

6.1. Configure the LTE on the phone

1. Press **Menu** → **LTE Setting**, enable LTE feature
2. After enable LTE, press ↓ key, you can see **Network service, Network type, Signal strength and IMSI**.

6.2. Configure the account on the LTE network

Under LTE network, you can set the phone accounts through auto provision or phone LCD.

Auto provision configuration account:

```
#!version:1.0.0.1
#####
##                               Account1 Basic Settings                               ##
#####
account.1.display_name =
account.1.auth_name =
account.1.user_name =
account.1.password =
account.1.sip_server.1.address =
account.1.sip_server.1.port =
```

LCD menu configuration account.

Press **Menu**→ **Settings**→ **Advanced settings** (default password: admin)→ **Accounts**, input the account info.

7. FAQ

7.1. How to reset to factory

There are 3 methods for factory reset:

1. Factory reset via phone:



a) Press the key

b) Select "Settings", then press the soft key "Enter"

c) Select "Advanced Settings", then press the soft key "Enter"

d) Input the access password, then press the soft key "Enter"

e) Select "Reset to factory", then press the soft key "Enter"

f) Press the soft key "OK", then the phone will be reboot and resumed to factory default settings

2. Factory reset via Web:

a) Key in the IP address of phone with a browser,

b) Access the webpage of phone as the role of "admin", username/password is admin/admin.

c) Select "Phone"

d) Select "Upgrade"

e) Click the button "Reset to Factory"

f) Click the button "OK"

3. Factory reset during starting:

a) Hold the key "*" and "#" while power on for 5 seconds

b) The phone will be reboot and resumed to factory default setting

7.2. Upgrade the firmware on safe mode

If the phone can't be started successfully, user is able to upgrade the firmware on post mode,

- a) Setup a TFTP Server and set the PC's IP address as "192.168.1.200"
- b) Copy the kernel file we supplied to the root menu of TFTP Server
- c) Ensure the TFTP Server and phone are connected to the same network switch and both reachable
- d) Long Press the key "*" and "1" to upgrade the kernel file, and then plug in power until upgrading information displayed on LCD
- e) The phone will start downloading file from TFTP server
- f) After downloading completed, the phone will be automatically upgraded
- g) After upgrading completed, the phone will be started with the factory default settings

7.3. How to make IP Peer to Peer call

1. Press it in dialing status
2. To make a IP peer to peer call

Using press "*" to choose "." that in the IP address. For example, to dial "192.168.1.100", just need input "192","*","168", "*", "1", "*", "100".

3. Disable the IP call feature

Via webpage modify the make IP call feature:

Phone→Feature →Accept SIP Trust Server Only, press "Enable".

- Preferences
- Features**
- Upgrade
- Auto Provision
- Configuration
- Dial Plan
- Voice
- Phone Lock
- Security
- Debug
- Trusted Certificates
- Server Certificates

+ Call Forward

+ Do Not Disturb

- General Information

| | | |
|--------------------------------|-----------------------------------------------------|--------|
| Inter Digit Time(secs) | <input type="text" value="8"/> | (1~14) |
| Auto Answer | <input type="text" value="Disabled"/> | |
| Call Waiting | <input type="text" value="Enabled"/> | |
| Hotline | <input type="text"/> | |
| Hotline Time-out(0~180 secs) | <input type="text" value="4"/> | |
| Key As Send | <input type="text" value="#"/> | |
| Dial-now Time-out(secs) | <input type="text" value="1"/> | |
| Busy Tone Timer(secs) | <input type="text" value="0"/> | |
| Return Code When Refuse | <input type="text" value="486 (Busy here)"/> | |
| Return Code When DND | <input type="text" value="480 (Temporarily not a"/> | |
| RFC 2543 Hold | <input type="text" value="Enabled"/> | |
| Use Outbound Proxy in Dialog | <input type="text" value="Disabled"/> | |
| Login Time-out(1~1000 minutes) | <input type="text" value="10"/> | |
| Hide DTMF | <input type="text" value="Disabled"/> | |
| Watch Dog | <input type="text" value="Enabled"/> | |
| Accept SIP Trust Server Only | <input type="text" value="Enabled"/> | |

8. Troubleshooting

8.1. The phone is failed to register to SIP server

1. First of all, check the IP address. If the LAN port is DHCP, please ensure the DHCP server has been enabled.
2. Check the network gateway
3. Check the DNS
4. Make sure the input account matched the one provided by Service Provider
5. Make sure SIP Server has been enabled already
6. Make sure the Port of SIP Server, it's 5060 by default

8.2. The phone is failed to gain IP address

1. Make sure the network cable has been plugged into the LAN port
2. Make sure the network cable or port of network switch are working fine,
3. Make sure the DHCP server has been enabled, and there are available IP address
4. Try to set the LAN port as Statics IP

8.3. Only one party can hear from another on calling

1. Try to make a IP peer to peer call, to make sure the mic and speaker are working fine
2. Enable STUN via Web
3. Set the address of STUN Server, for example stun.sipgate.com
4. Present this operation above and the phone will be reboot
5. Try to make a normal call again

9. Abbreviation

DND: Do Not Disturb

CFWD: Call Forward

Bxfer: Blind Transfer

Conf: Conference

Num: Number

SIP: Session Initiate Protocol

RTP: Real-time Transport Protocol

SDP: Session Description Protocol

VPN: Virtual Private Network

VLAN: Virtual Local Area Network

QoS: Quality of Service

Syslog: System log

UDP: User Data Protocol

TCP: Transmission Control Protocol

TLS: Transport Layer Security Protocol

BLF: Busy Lamp Field

DNS: Domain Name System

SRTP: Secure Real-time Transport Protocol

NTP: Network Time Protocol

VAD: Voice Activity Detection

CNG: Comfort Noise Generator

10. FCC Caution

Any Changes or modifications not expressly approved by the party responsible for compliance could void the user's authority to operate the equipment.

The device complies with part 15 of the FCC Rules. Operation is subject to the following two conditions: (1) The device may not cause harmful interference, (2) the device must accept any interference received, including interference that may cause undesired operation.

Note: This equipment has been tested and found to comply with the limits for a Class B digital device, Pursuant to part 15 of the FCC Rules. These limits are designed to provide reasonable protection, uses and can radiate radio frequency energy, and if not installed and used in accordance with the instructions, may cause harmful interference to radio communication. However, there is no guarantee that interference will not occur in a particular installation. If this equipment does cause harmful interference to radio or reception, which can be determined by turning the equipment off and on, the user is encouraged to try to correct the interference by one or more of the following measures:

Reorient or relocate the receiving antenna.

Increase the separation between the equipment and receiver.

Connect the equipment into an outlet on a circuit different from that to which the receiver is connected.

Consult the dealer or an experienced radio/TV technician for help.